



DESCRIPTION

The 2SD1664 is available in SOT-89 Package.

FEATURES

- Available in SOT-89 Package.

ORDERING INFORMATION

Package Type	Part Number
SOT-89	2SD1664P
	2SD1664Q
	2SD1664R
Note	SPQ: 1,000pcs/Reel
AiT provides all RoHS Compliant Products	

PIN DESCRIPTION

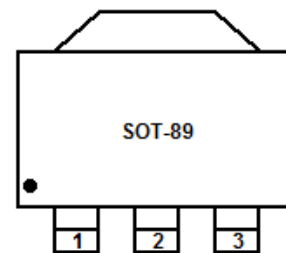

1. Base
2. Collector
3. Emitter



ABSOLUTE MAXIMUM RATINGS

T_A=25°C

V _{CBO} , Collector Base Voltage	40V
V _{CEO} , Collector Emitter Voltage	32V
V _{EBO} , Emitter Base Voltage	5V
I _C , Collector Current - DC	1A
I _{CP} , Collector Current - Pulse ^{NOTE1}	2A
P _{tot} , Total Power Dissipation	0.5W 2W ^{NOTE2}
T _J , Junction Temperature	150°C
T _{STG} , Storage Temperature Range	-55°C ~150°C

Stresses above may cause permanent damage to the device. These are stress ratings only and functional operation of the device at these or any other conditions beyond those indicated in the Electrical Characteristics are not implied. Exposure to absolute maximum rating conditions for extended periods may affect device reliability.

NOTE1: Single pulse, P_w = 100 ms.

NOTE2: When mounted on a 40 X 40 X 0.7 mm ceramic board.

ELECTRICAL CHARACTERISTICS

T_A=25°C

Parameter	Symbol	Conditions	Min.	Typ.	Max.	Unit	
Collector Base Breakdown Voltage	V _{(BR)CBO}	I _C =50μA	40	-	-	V	
Collector Emitter Breakdown Voltage	V _{(BR)CEO}	I _C =1mA	32	-	-	V	
Emitter Base Breakdown Voltage	V _{(BR)EBO}	I _E =50μA	5	-	-	V	
Collector Cutoff Current	I _{CBO}	V _{CB} =20V	-	-	0.5	μA	
Emitter Cutoff Current	I _{EBO}	V _{EB} =4V	-	-	0.5	μA	
Collector Emitter Saturation Voltage	V _{CE(sat)}	I _C =500mA, I _B =50mA	-	-	0.4	V	
DC Current Gain	h _{FE}	V _{CE} =3V, I _C = 100mA Current Gain Group	P	82	-	180	-
			Q	120	-	270	
			R	180	-	390	
Transition Frequency	f _T	-I _E =50 mA, V _{CE} =5V, f=100MHz	-	150	-	MHz	
Output Capacitance	C _{ob}	V _{CB} =10 V, f=1 MHz	-	15	-	pF	



TYPICAL PERFORMANCE CHARACTERISTICS

1. Grounded Emitter Propagation Characteristics
2. Grounded Emitter Output Characteristics

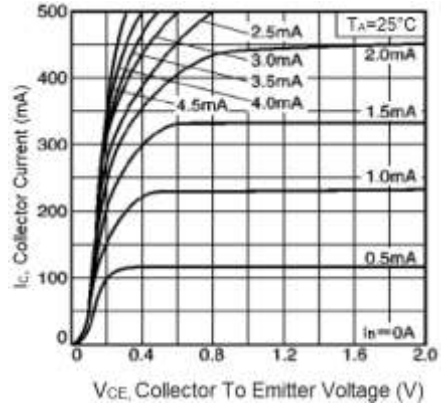
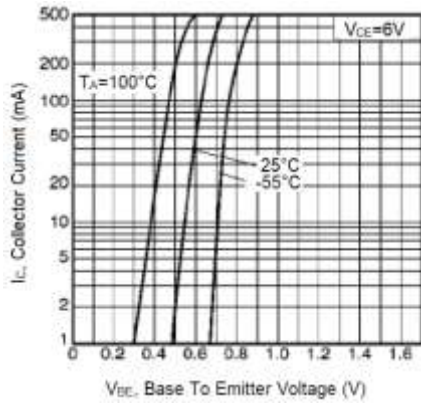

3. DC Current Gain vs. Collector Current (I)
4. DC Current Gain vs. Collector Current (II)

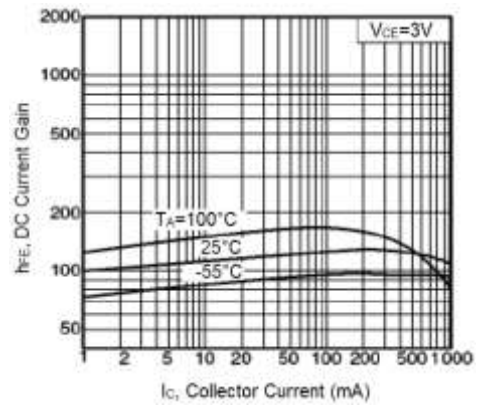
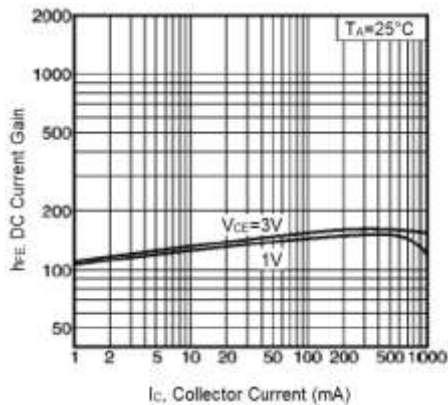

5. Collector-Emitter Saturation Voltage vs. Collector Current (I)
6. Collector-Emitter Saturation Voltage vs. Collector Current (II)

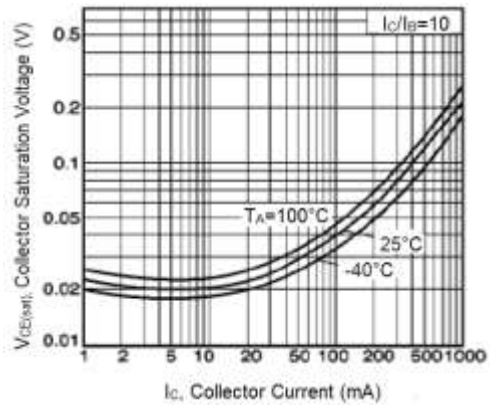
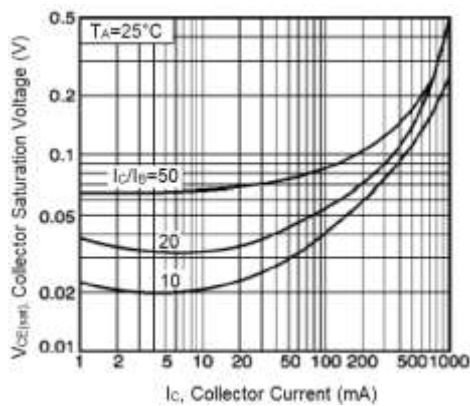



7. Gain Bandwidth Product vs. Emitter Current

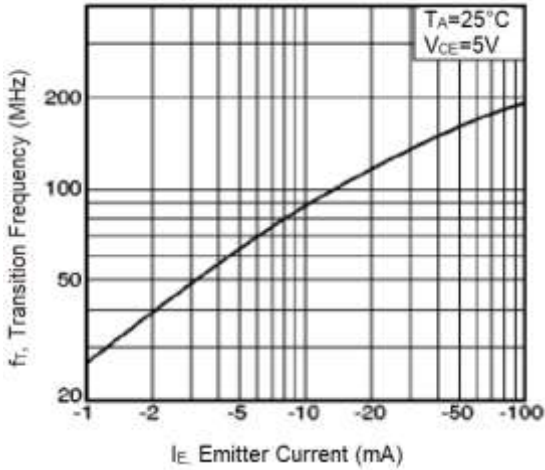

8. Collector output Capacitance vs. Collector-Base Voltage

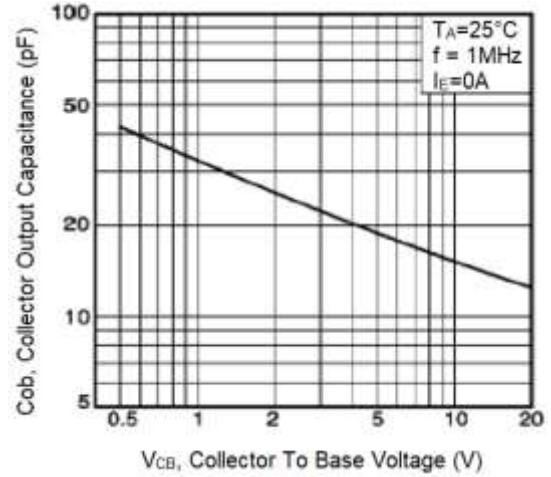

9. Safe Operation area

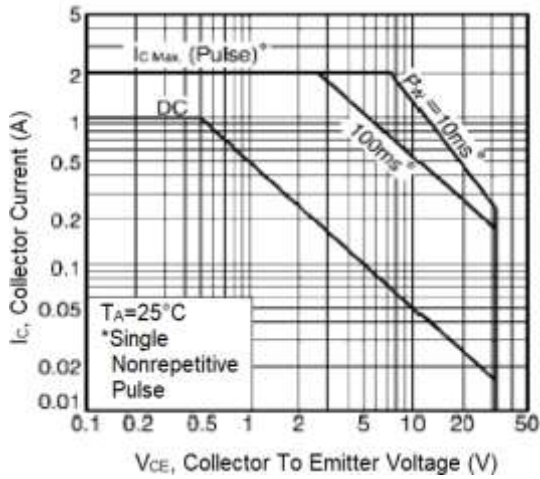

10. Transient Thermal Resistance

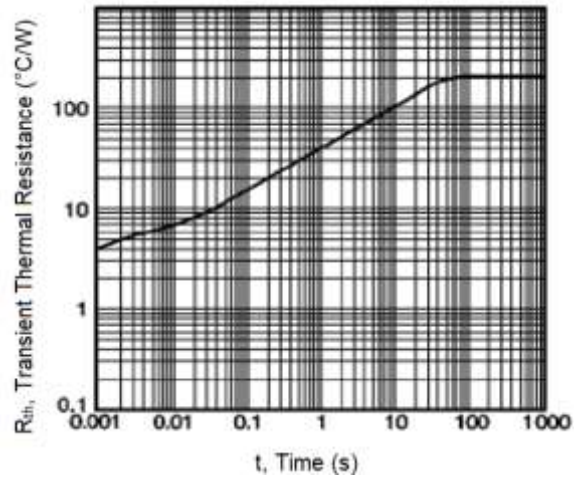



PACKAGE INFORMATION

Dimension in SOT-89 (Unit: mm)

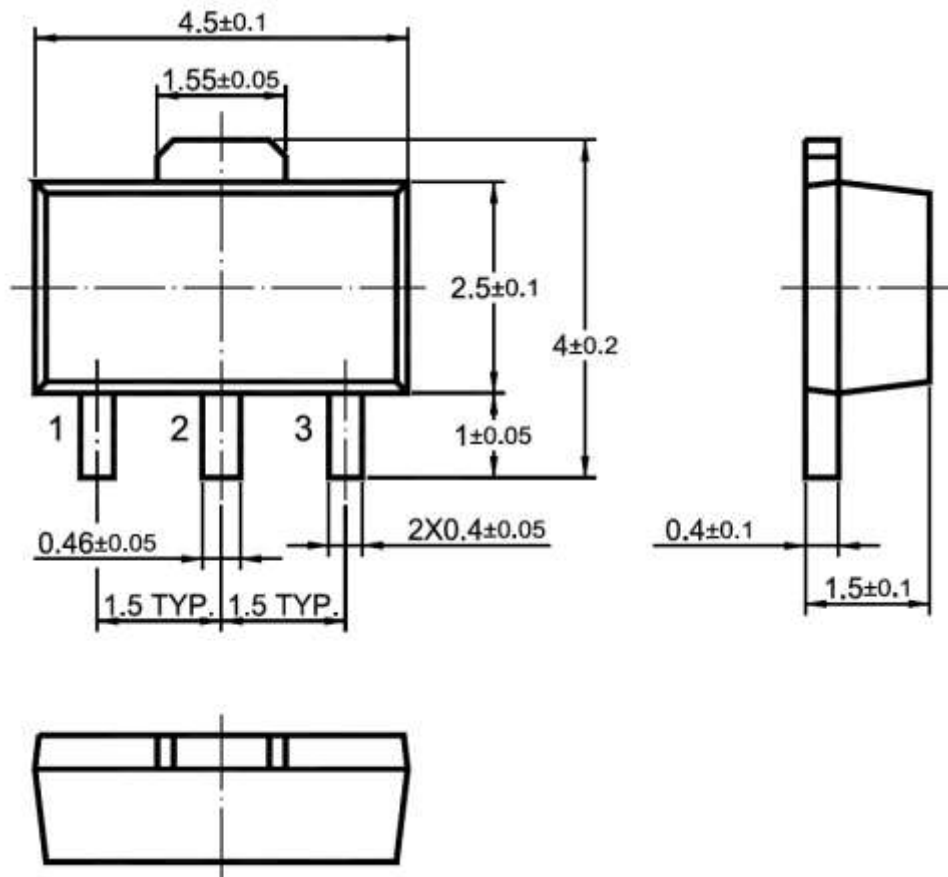



IMPORTANT NOTICE

AiT Semiconductor Inc. (AiT) reserves the right to make changes to any its product, specifications, to discontinue any integrated circuit product or service without notice, and advises its customers to obtain the latest version of relevant information to verify, before placing orders, that the information being relied on is current.

AiT Semiconductor Inc.'s integrated circuit products are not designed, intended, authorized, or warranted to be suitable for use in life support applications, devices or systems or other critical applications. Use of AiT products in such applications is understood to be fully at the risk of the customer. As used herein may involve potential risks of death, personal injury, or server property, or environmental damage. In order to minimize risks associated with the customer's applications, the customer should provide adequate design and operating safeguards.

AiT Semiconductor Inc. assumes to no liability to customer product design or application support. AiT warrants the performance of its products of the specifications applicable at the time of sale.