



DESCRIPTION

The A4056 is a complete constant-current /constant -voltage linear charger for single cell lithium-ion batteries. Its Thin SOT package and low external component count make the A4056 ideally suited for portable applications. Furthermore, the A4056 is specifically designed to work within USB power specifications.

No external sense resistor is needed, and no blocking diode is required due to the internal MOSFET architecture. Thermal feedback regulates the charge current to limit the die temperature during high power operation or high ambient temperature. The charge voltage is fixed at 4.2V, and the charge current can be programmed externally with a single resistor. The A4056 automatically terminates the charge cycle when the charge current drops to 1/10th the programmed value after the final float voltage is reached.

When the input supply (wall adapter or USB supply) is removed, the A4056 automatically enters a low current state, dropping the battery drain current to less than 2µA. The A4056 can be put into shutdown mode, reducing the supply current to 25µA.

Other features include charge current monitor, under-voltage lockout, automatic recharge and a status pin to indicate charge termination and the presence of an input voltage.

The A4056 is available in SOT-26 package.

ORDERING INFORMATION

Package Type	Part Number	
SOT-26	E6	A4056E6R
SPQ: 3,000pcs/Reel		A4056E6VR
Note	V: Halogen free Package R: Tape & Reel	
AiT provides all RoHS products		

FEATURES

- Programmable charge current up to 500mA
- No MOSFET, sense resistor or blocking diode required
- Complete linear charger in Thin SOT package for single cell lithium-ion batteries
- Constant-current/constant-voltage operation with thermal regulation to maximize charge rate without risk of overheating
- Charges single cell li-ion batteries directly from USB port
- Preset 4.2V charge voltage with 1% accuracy
- Charge current monitor output for gas gauging
- Charge status output pin
- C/10 charge termination
- 25µA supply current in shutdown
- 2.9V trickle charge threshold (A4056)
- Soft-start limits inrush current
- Available in SOT-26 package

APPLICATION

- Cellular Telephones, PDAs, MP3 Players
- Bluetooth Applications

TYPICAL APPLICATION

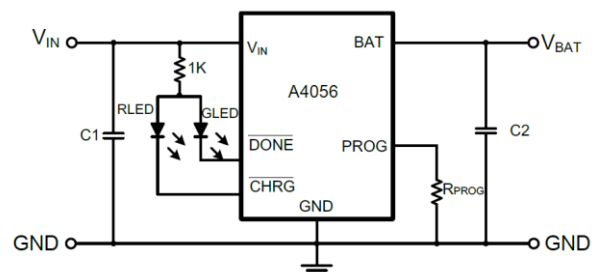

NOTE: C1=4.7µF, C2=10µF, I_{BAT}=(V_{PROG}/R_{PROG})*1000



PIN DESCRIPTION

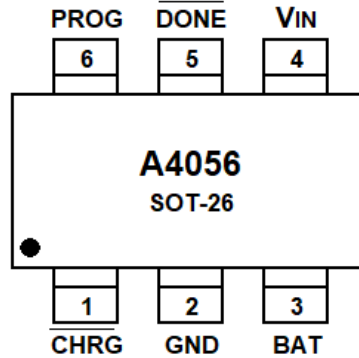

Pin #	Symbol	Function
1	$\overline{\text{CHRG}}$	Open-Drain Charge Status Output. When the battery is charging, the CHRG pin is pulled low by an internal N-channel MOSFET. When the charge cycle is completed, a weak pull-down of approximately 20 μA is connected to the CHRG pin, indicating an “AC present” condition. When the A4056 detects an under voltage lockout condition, CHRG is forced high impedance.
2	GND	Ground.
3	BAT	Charge current output. Provides charge current to the battery and regulates the final float voltage to 4.2V. An internal precision resistor divider from this pin sets the float voltage which is disconnected in shutdown mode.
4	V_{IN}	Positive input supply voltage. Provides power to the charger. V_{IN} should be bypassed with at least a 1 μF capacitor. When V_{IN} drops to within 30mV of the BAT pin voltage, the A4056 enters shutdown mode, dropping I_{BAT} to less than 2 μA .
5	$\overline{\text{DONE}}$	Full indication output, when fully charged, DONE port is an internal N-channel MOSFET placed in low position. In the charging process, low-power lock condition is detected; the input is too high to detect locking conditions, DONE-Z state.
6	PROG	Charge current program, charge current monitor and shutdown pin. The charge current is programmed by connecting a 1% resistor, R_{PROG} to ground. When charging in constant-current mode, this pin serves to 1V. In all modes, the voltage on this pin can be used to measure the charge current using the following formula: $I_{\text{BAT}} = (V_{\text{PROG}}/R_{\text{PROG}}) \times 1000$ The PROG pin can also be used to shut down the charger. Disconnecting the program resistor from ground allows a 3 μA current to pull the PROG pin high. When it reaches the 1.21V shutdown threshold voltage, the charger enters shutdown mode, charging stops and the input supply current drops to 25 μA . This pin is also clamped to approximately 2.4V. Driving this pin to voltages beyond the clamp voltage will draw currents as high as 1.5mA. Reconnecting R_{PROG} to ground will return the charger to normal operation.



ABSOLUTE MAXIMUM RATINGS

V _{IN} , Input Supply Voltage		V _{SS} -0.3V ~ V _{SS} +10V
V _{PROG} , PROG pin Voltage		V _{SS} -0.3V ~ V _{IN} +0.3V
V _{BAT} , BAT pin Voltage		V _{SS} -0.3V ~ 7V
V _{CHRG} , CHAG pin Voltage		V _{SS} -0.3V ~ V _{SS} +10V
P _D , Power Dissipation	SOT-26	250mW
I _{BAT} , BAT pin Current		500mA
I _{PROG} , PROG pin Current		800μA
T _{OPA} , Operating Ambient Temperature		-40°C ~ +85°C
T _{STR} , Storage Temperature		-65°C ~ +125°C

Stress beyond above listed "Absolute Maximum Ratings" may lead permanent damage to the device. These are stress ratings only and operations of the device at these or any other conditions beyond those indicated in the operational sections of the specifications are not implied. Exposure to absolute maximum rating conditions for extended periods may affect device reliability.



ELECTRICAL CHARACTERISTICS

T_A=25°C, unless otherwise noted

Parameter	Symbol	Conditions	Min.	Typ.	Max.	Unit
Input Supply Voltage	V _{IN}		4.25	-	6.5	V
Input Supply Current	I _{CC}	Charge mode, R _{PROG} =10k	-	300	2000	μA
		Standby mode	-	200	500	
		Shutdown mode (R _{PROG} not connected, V _{IN} <V _{BAT} or V _{IN} <V _{UV})	-	25	50	
Regulated Output Voltage	V _{FLOAT}	0°C≤T _A ≤85°C, I _{BAT} =40mA	4.16	4.2	4.25	V
BAT Pin Current	I _{BAT}	R _{PROG} =10k, Current mode	93	100	107	mA
		R _{PROG} =2k, Current mode	465	500	535	
		Standby mode, V _{BAT} =4.2V	0	-2.5	-6	μA
		Shutdown mode	-	1	2	
		Sleep mode, V _{IN} =0V	-	1	2	
Trickle Charge Current	I _{TRIKL}	V _{BAT} <V _{TRIKL} , R _{PROG} =2k	93	100	107	mA
Trickle Charge Threshold Voltage	V _{TRIKL}	R _{PROG} =10k, V _{BAT} Rising	2.8	2.9	3.0	V
Trickle Voltage Hysteresis Voltage	V _{TRHYS}	R _{PROG} =10k	60	80	110	mV
V _{IN} Undervoltage Lockout Threshold	V _{UV}	From V _{IN} low to high	3.7	3.8	3.93	V
V _{IN} Undervoltage Lockout Hysteresis	V _{UVHYS}		150	200	300	mV
Manual Shutdown Threshold Voltage	V _{msd}	PROG pin rising	1.15	1.21	1.30	V
		PROG pin falling	0.9	1.0	1.1	
V _{IN} -V _{BAT} Lockout Threshold Voltage	V _{asd}	V _{IN} from low to high	70	100	140	mV
		V _{IN} from high to low	5	30	50	
C/10 Termination Current Threshold	I _{term}	R _{PROG} =10k	0.085	0.10	0.115	mA/
		R _{PROG} =2k	0.085	0.10	0.115	mA
PROG Pin Voltage	V _{PROG}	R _{PROG} =10k, Current mode	0.93	1.0	1.07	V
CHRG Pin Weak Pull-Down Current	I _{CHRG}	V _{CHRG} =5V	8	20	35	μA
CHRG Pin Output Low Voltage	V _{CHRG}	I _{CHRG} =5mA	-	0.35	0.6	V
Recharge Battery threshold Voltage	ΔV _{RECG}	V _{FLOAT} - V _{RECHRG}	-	100	200	mV



TYPICAL PERFORMANCE CHARACTERISTICS

1. Charge Current vs. Battery Voltage

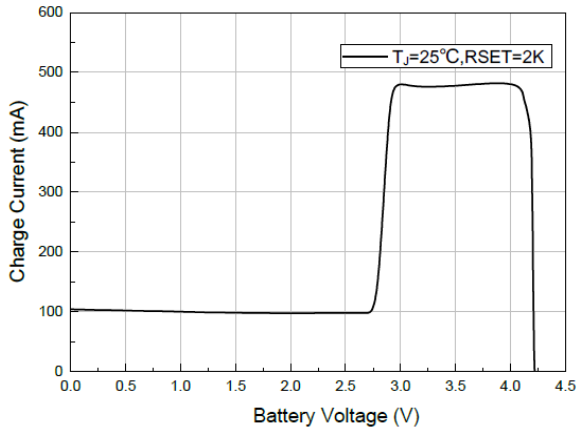

2. Charge Current vs. PROG Pin Voltage

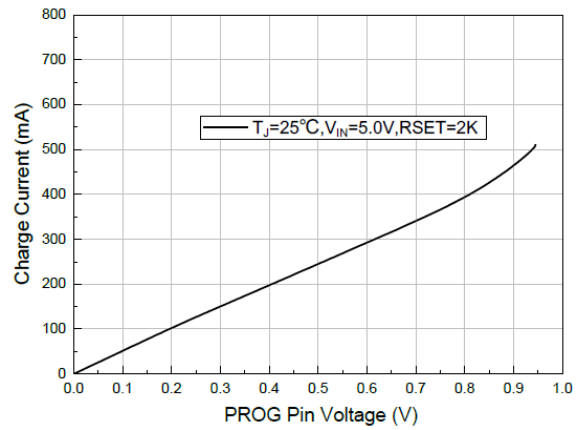

3. Charge Current vs. Supply Voltage

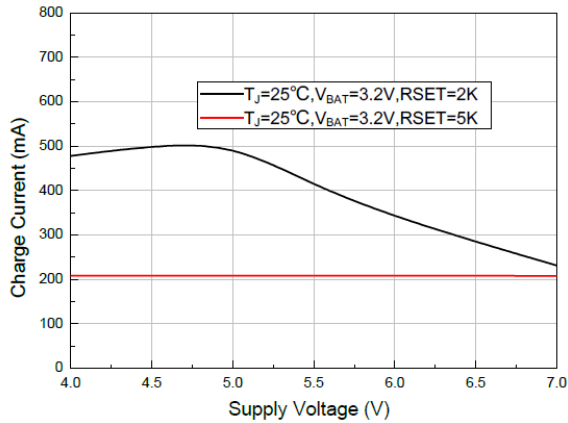

4. PROG Pin Pull-up Current vs. PROG Pin Voltage

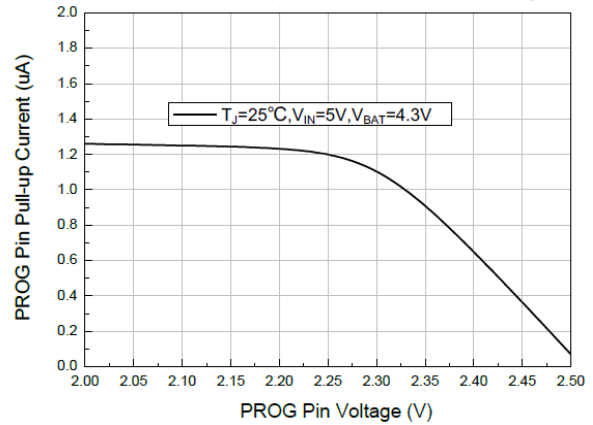

5. Charge Pin Current vs. Charge Voltage (Weak Pull-Down State)

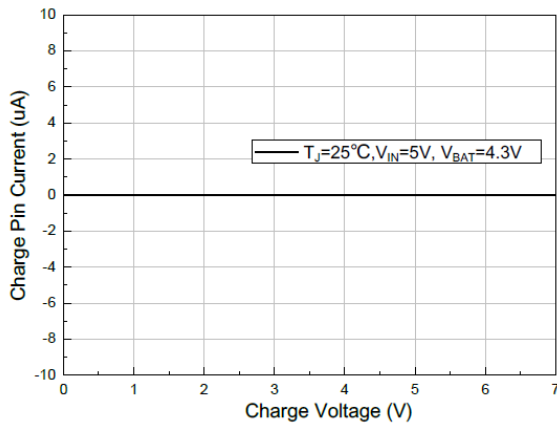

6. Charge Pin Current vs. Charge Voltage (Strong Pull-Down State)

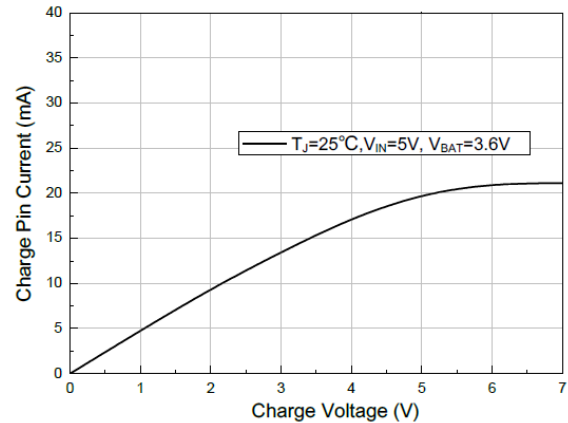



7. PROG Pin Voltage vs. Supply Voltage

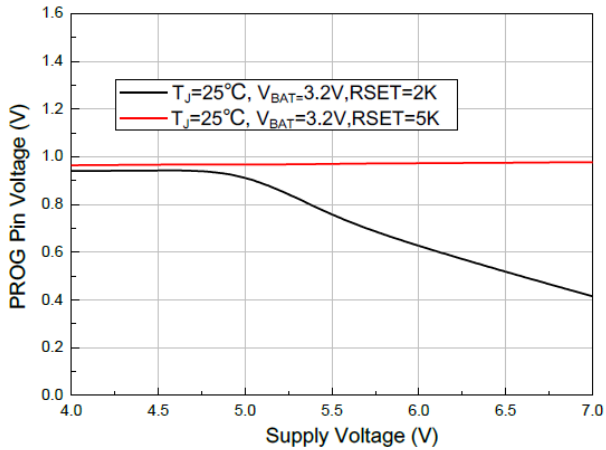

8. Trickle Charge Current vs. Supply Voltage

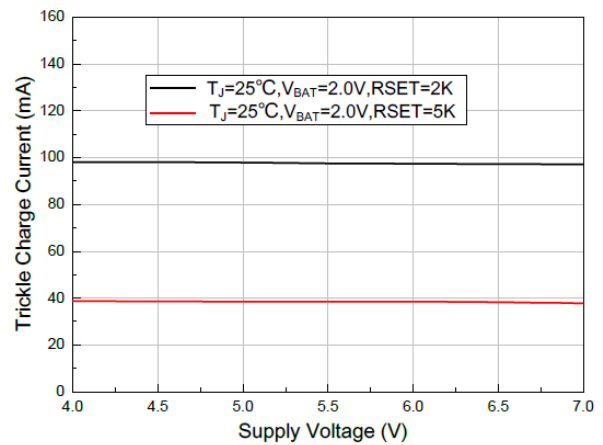

9. Regulated Output (Float) Voltage vs. Supply Voltage

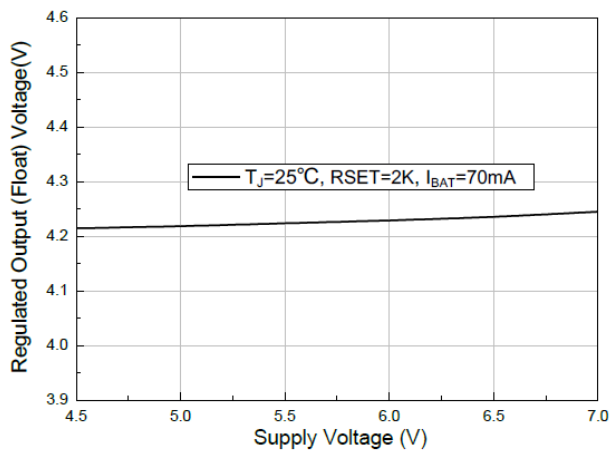

10. PROG Pin Voltage vs. Temperature

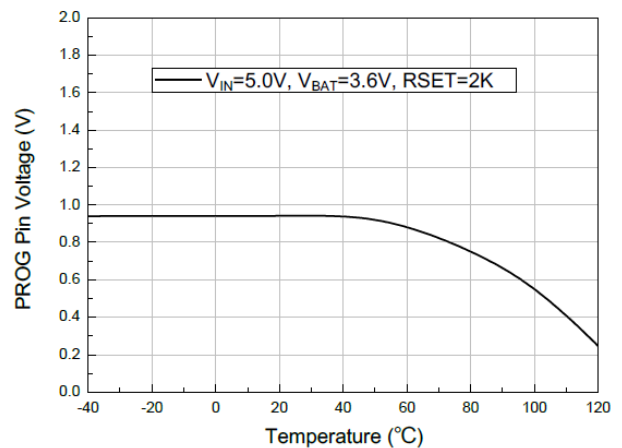

11. PROG Pin Pull-up Current vs. Temperature

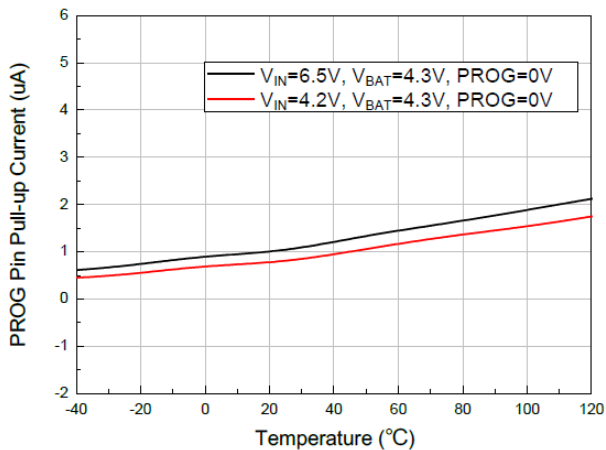

12. VBAT vs. Temperature

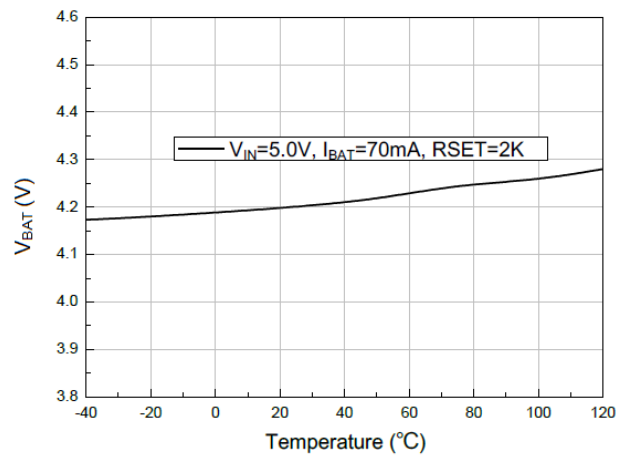



13. Recharge Battery threshold Voltage vs. Temperature

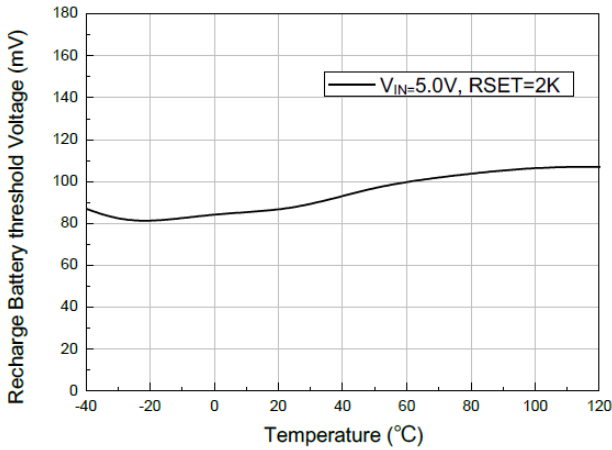

14. Charge Pin Current vs. Temperature

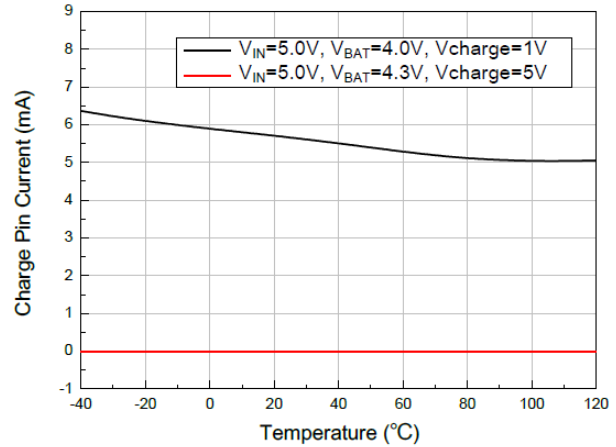

15. Trickle Charge Current vs. Temperature

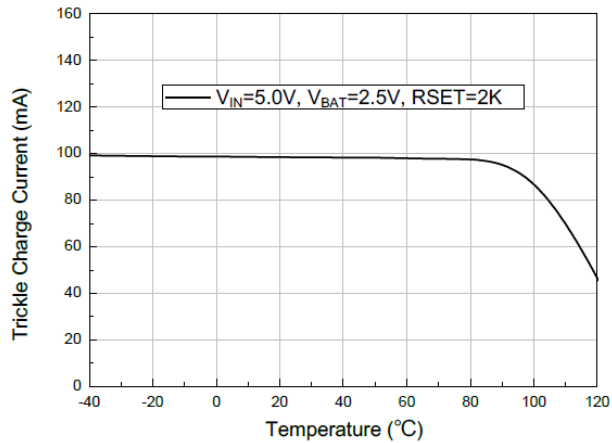

16. Trickle charge Threshold Voltage vs. Temperature

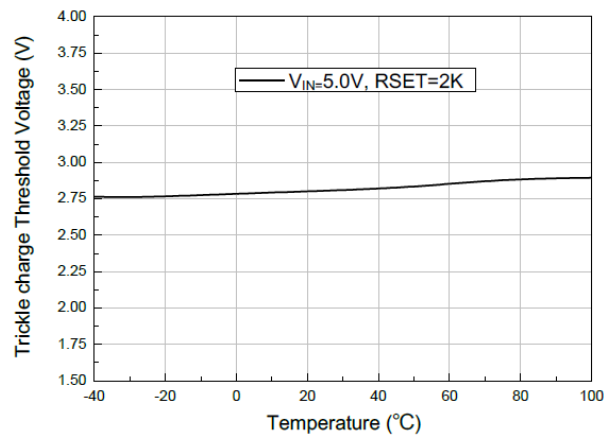

17. Charge Current vs. Temperature

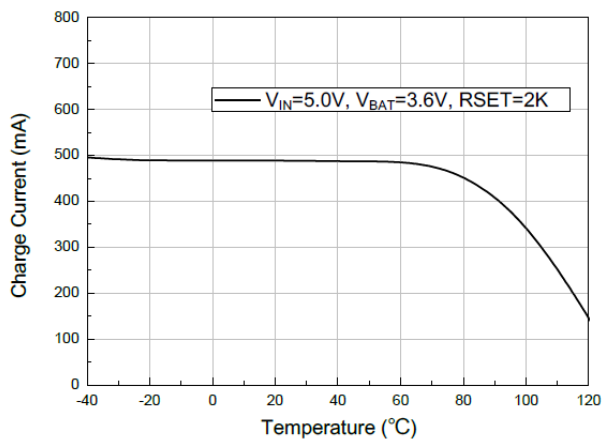

18. Power Tube Resistance vs. Temperature

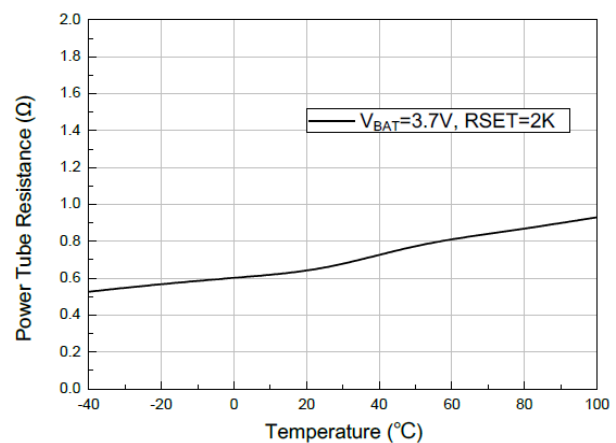



BLOCK DIAGRAM

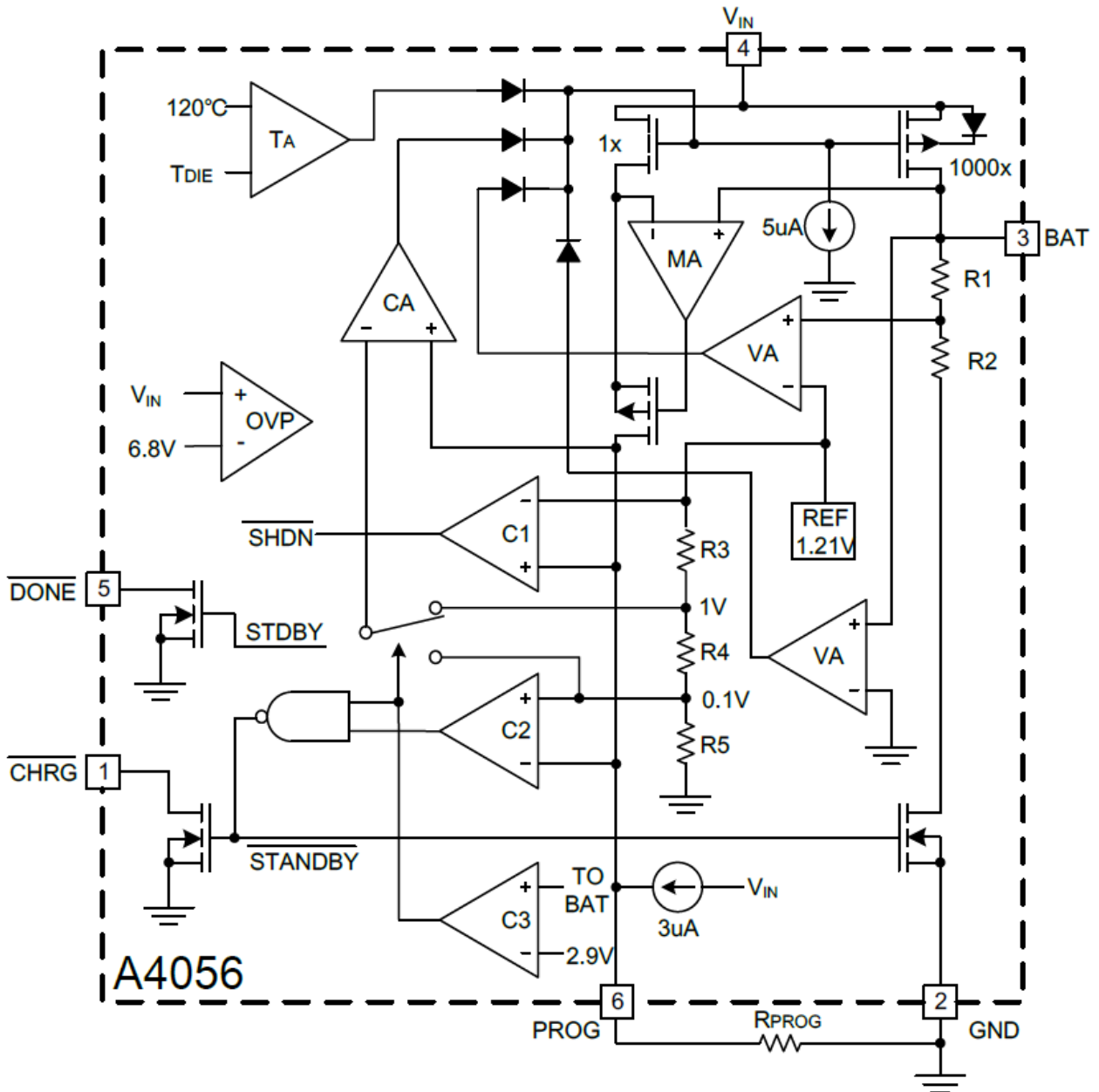



PACKAGE INFORMATION

Dimension in SOT-26 Package (Unit: mm)

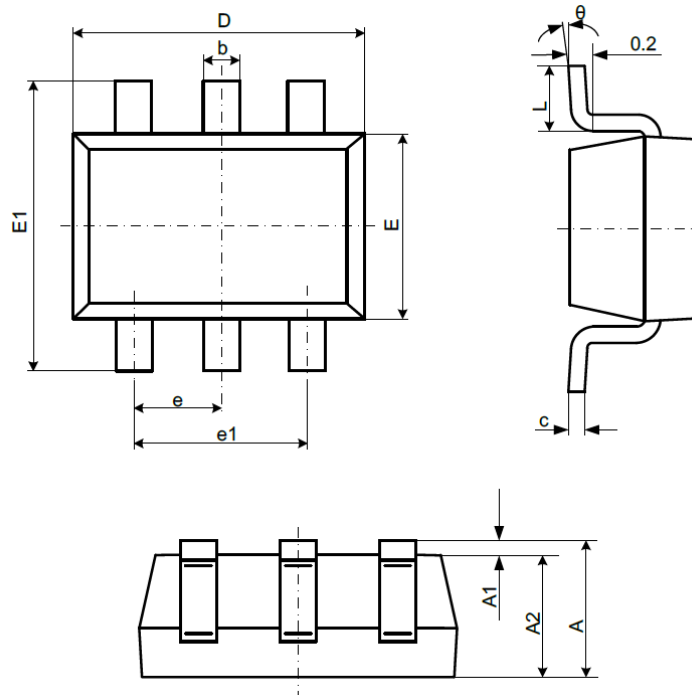

Symbol	Millimeters		Inches	
	Min	Max	Min	Max
A	1.050	1.250	0.041	0.049
A1	0.000	0.100	0.000	0.004
A2	1.050	1.150	0.041	0.045
b	0.300	0.500	0.012	0.020
c	0.100	0.200	0.004	0.008
D	2.820	3.020	0.111	0.119
E	1.500	1.700	0.059	0.067
E1	2.650	2.950	0.104	0.116
e	0.950 BSC		0.037 BSC	
e1	1.800	2.000	0.071	0.079
L	0.300	0.600	0.012	0.024
θ	0°	8°	0°	8°



IMPORTANT NOTICE

AiT Semiconductor Inc. (AiT) reserves the right to make changes to any its product, specifications, to discontinue any integrated circuit product or service without notice, and advises its customers to obtain the latest version of relevant information to verify, before placing orders, that the information being relied on is current.

AiT Semiconductor Inc.'s integrated circuit products are not designed, intended, authorized, or warranted to be suitable for use in life support applications, devices or systems or other critical applications. Use of AiT products in such applications is understood to be fully at the risk of the customer. As used herein may involve potential risks of death, personal injury, or severe property, or environmental damage. In order to minimize risks associated with the customer's applications, the customer should provide adequate design and operating safeguards.

AiT Semiconductor Inc. assumes to no liability to customer product design or application support. AiT warrants the performance of its products of the specifications applicable at the time of sale.