



DESCRIPTION

The 1SS400CS is available in SOD-923 Package.

ORDERING INFORMATION

Package Type	Part Number
SOD-923	1SS400CS
Note	SPQ: 8,000pcs/Reel
AiT provides all RoHS Compliant Products	

FEATURES

- Extremely small surface mounting type.
- High Speed.
- High reliability.
- Construction
Silicon epitaxial planar
- Available in SOD-923 Package

APPLICATIONS

- High speed switching

PIN DESCRIPTION





ABSOLUTE MAXIMUM RATINGS

T_A=25°C

V _{RM} , Peak Reverse Voltage	90V
V _R , DC Reverse Voltage	80V
I _{FM} , Peak Forward Current	225mA
I _O , Mean Rectifying Current	100mA
I _{surge} , Surge Current (1s)	500mA
T _J , Junction Temperature(Max)	125°C
T _{STG} , Storage Temperature	-55°C~125°C

Stresses above may cause permanent damage to the device. These are stress ratings only and functional operation of the device at these or any other conditions beyond those indicated in the Electrical Characteristics are not implied. Exposure to absolute maximum rating conditions for extended periods may affect device reliability.

ELECTRICAL CHARACTERISTICS

T_A=25°C

Parameter	Symbol	Conditions	Min.	Typ.	Max.	Unit
Forward Voltage	V _F	I _F =100mA	-	-	1.2	V
Reverse Current	I _R	V _R =80V	-	-	0.1	μA
Capacitance Between Terminals	C _T	V _R =0.5V, f=1MHz	-	0.72	3.0	pF
Reverse Recovery Time	t _{rr}	V _R =6V, I _F =10mA, R _L =100Ω	-	-	4	ns



TYPICAL CHARACTERISTICS

$T_A=25^\circ\text{C}$

Figure 1. Forward Characteristics

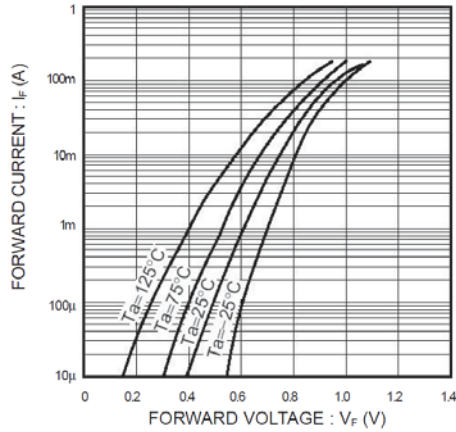

Figure 2. Reverse Characteristics

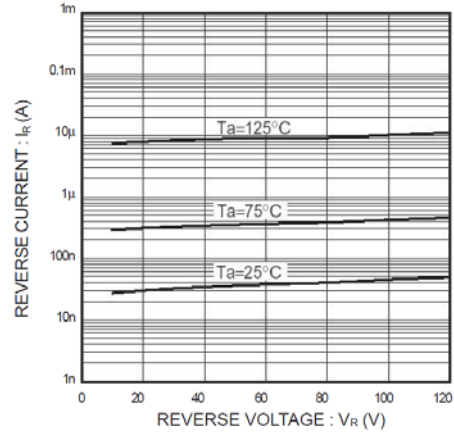

Figure 3. Capacitance Between Terminals

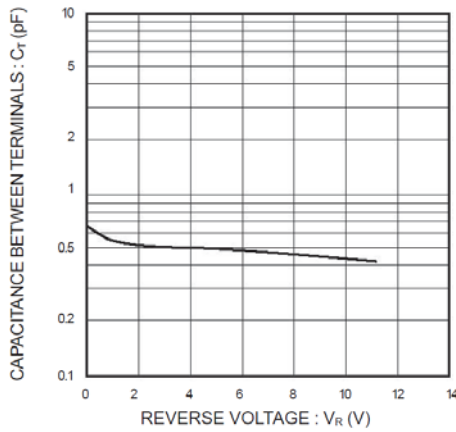

Figure 4. Reverse Recovery Time Characteristics

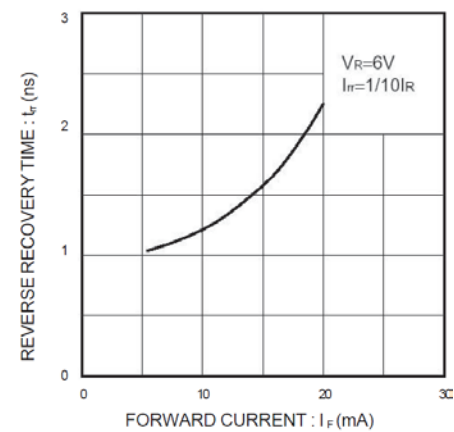

Figure 5. Surge Current Characteristics

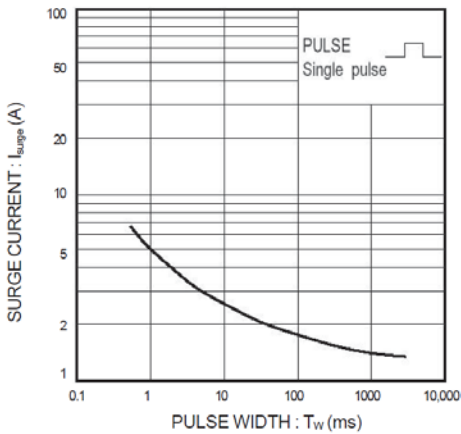
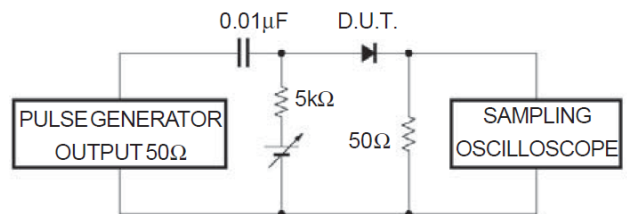

Figure 6. Reverse Recovery Time (t_{rr})

Measurement Circuit





PACKAGE INFORMATION

Dimension in SOD-923 (Unit: mm)

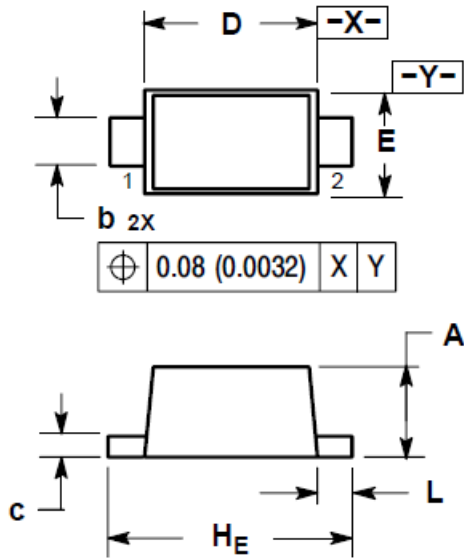

SOLDERING FOOTPRINT

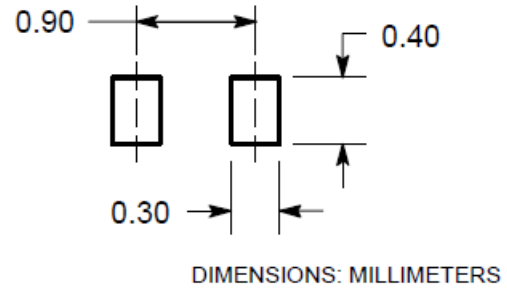

Symbol	Millimeter		Inches	
	Min	Max	Min	Max
A	0.34	0.40	0.013	0.016
b	0.15	0.25	0.006	0.010
c	0.07	0.17	0.003	0.007
D	0.75	0.85	0.030	0.033
E	0.55	0.65	0.022	0.026
HE	0.95	1.05	0.037	0.041
L	0.05	0.15	0.002	0.006



IMPORTANT NOTICE

AiT Components (AiT) reserves the right to make changes to any its product, specifications, to discontinue any integrated circuit product or service without notice, and advises its customers to obtain the latest version of relevant information to verify, before placing orders, that the information being relied on is current.

AiT Components' integrated circuit products are not designed, intended, authorized, or warranted to be suitable for use in life support applications, devices or systems or other critical applications. Use of AiT products in such applications is understood to be fully at the risk of the customer. As used herein may involve potential risks of death, personal injury, or server property, or environmental damage. In order to minimize risks associated with the customer's applications, the customer should provide adequate design and operating safeguards.

AiT Components assumes to no liability to customer product design or application support. AiT warrants the performance of its products of the specifications applicable at the time of sale.