



DESCRIPTION

The A4772 is a low voltage, single N-MOSFET high-side power switch, optimized for self-powered and bus-powered Universal Serial Bus (USB) applications. The A4772 equipped with a charge pump circuitry to drive the internal MOSFET switch; the switch's low $R_{DS(ON)}$, 80mΩ, meets USB voltage drop requirements and a flag output is available to indicate fault conditions to the local USB controller.

Additional features include soft-start to limit inrush current during plug-in, thermal shutdown to prevent catastrophic switch failure from high-current loads, under-voltage lockout (UVLO) to ensure that the device remains off unless there is a valid input voltage present. The maximum current is limited to typically 2.1A/1.5A/1A/0.65A/2.5A through the switch of A4772A/B/C/D/E, lower quiescent current as 25uA making this device ideal for portable battery-operated equipment.

The A4772 is available in SOT-25 package.

ORDERING INFORMATION

Package Type	Part Number	
SOT-25	E5	A4772ZE5R-XTD A4772ZE5VR-XTD
Note	X: Pin Type Z: Continuous Load Current A : 1.5A / B : 1A C : 0.8A / D : 0.5A / E : 2.0A T: Active H: High; L: Low for A pin D: Output Discharge N: No Output Discharge Y: Output Discharge V: Halogen free Package R: Tape & Reel	
AiT provides all RoHS products		

FEATURES

- Wide Input Voltage Ranges : 2.5V to 5.5V
- Compliant to USB Specifications
- Typical $R_{DS(ON)}$: 80mΩ
- 1.7V Typical Under-Voltage Lockout (UVLO)
- Output Can Be Forced Higher Than Input (Off-State)
- Low Supply Current :
 - 25uA Typical at Switch on State
 - 1uA Typical at Switch off State
- Guaranteed 1.5A/1A/0.8A/0.5A/2.0A for A4772A/B/C/D/E Continuous Load Current
- Open-Drain Fault Flag Output
- Hot Plug-In Application (Soft-Start)
- Current Limiting Protection
- Thermal Shutdown Protection
- Reverse Current Flow Blocking (no body diode)
- Available in SOT-25 package

APPLICATION

- USB Bus/Self Powered Hubs
- USB Peripherals
- ACPI Power Distribution
- PC Card Hot Swap
- Notebook, Motherboard PCs
- Battery-Powered Equipment
- Hot-Plug Power Supplies
- Battery-Charger Circuits

TYPICAL APPLICATION

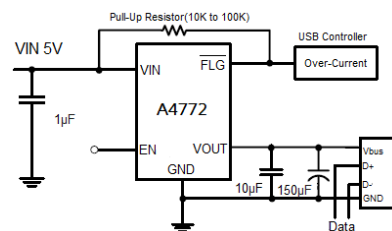

Basic Application Circuit with A4772



PIN DESCRIPTION

<p style="text-align: center;">Top View</p>		<p style="text-align: center;">Top View</p>	
Pin #		Symbol	Function
A type	B type		
1	5	V _{OUT}	Output Voltage
2	2	GND	Ground
3	1	FLG	Open-Drain Fault Flag Output
4	3	EN/ $\overline{\text{EN}}$	Chip Enable. Two versions are available, active-high and active-low.
5	4	V _{IN}	Power Input Voltage



ABSOLUTE MAXIMUM RATINGS

Supply Voltage	6.0V
Chip Enable Input Voltage	-0.3V~ 6.0V
Flag Voltage	6.0V
Power Dissipation, P _D @ T _A = 25°C	0.4W
θ _{JA} , Package Thermal Resistance ^{NOTE1}	250°C/W
Junction Temperature	125°C
Lead Temperature (Soldering, 10 sec.)	260°C
Storage Temperature Range	-65°C~150°C
Ambient Temperature Range	-40°C~85°C
ESD Susceptibility	
HBM (Human Body Mode)	4kV
MM (Machine Mode)	200V

Stress beyond above listed "Absolute Maximum Ratings" may lead permanent damage to the device. These are stress ratings only and operations of the device at these or any other conditions beyond those indicated in the operational sections of the specifications are not implied. Exposure to absolute maximum rating conditions for extended periods may affect device reliability.

NOTE1: θ_{JA} is measured in the natural convection at T_A = 25°C on a low effective single layer thermal conductivity test board of JEDEC 51-3 thermal measurement standard.



ELECTRICAL CHARACTERISTICS^{NOTE2}

$V_{IN}=5V, C_{IN}=C_{OUT}=1\mu F, T_A=25^\circ C$, unless otherwise specified

Parameter	Conditions		Min.	Typ.	Max.	Unit
Supply Voltage			2.5	-	5.5	V
Switch On Resistance	$V_{IN}=5V, I_{OUT}=1A$	A4772A/E	-	80	100	mΩ
	$V_{IN}=5V, I_{OUT}=0.5A$	A4772B/C/D				
Supply Current	Switch on, $V_{OUT}=OPEN$		-	25	45	μA
	Switch off, $V_{OUT}=OPEN$		-	0.1	1	μA
EN/ \overline{EN} Threshold	Logic-Low Voltage, $V_{IN} = 2.5V$ to $5.5V$		-	-	0.8	V
	Logic-High Voltage, $V_{IN}=2.5V$ to $5.5V$		2.0	-	-	
EN/ \overline{EN} Input Current	$V_{EN/\overline{EN}}=0$ to $5.5V$		-	0.01	-	μA
Output Leakage Current	$V_{EN}=0V, V_{\overline{EN}}=5V, R_{LOAD}=0\Omega$		-	0.5	10	μA
Output Turn-On Rise Time	10% to 90% of V_{OUT} rising		-	400	-	us
Current Limit	Current Ramp (<0.1A/ms) on V_{OUT}	A4772A	1.78	2.1	2.42	A
		A4772B	1.27	1.5	1.73	
		A4772C	0.85	1	1.15	
		A4772D	0.52	0.65	0.78	
		A4772E	2.3	2.5	2.7	
Short Circuit Fold-back Current (Hysteresis)	$V_{OUT}=0V$, measured prior to thermal shutdown	A4772A	-	1.3	-	A
		A4772B	-	0.8	-	
		A4772C	-	0.6	-	
		A4772D	-	0.4	-	
		A4772E	-	1.6	-	
FLAG Output Resistance	$I_{SINK}=1mA$		-	20	400	Ω
FLAG Off Current	$V_{\overline{FLG}}=5V$		-	0.01	1	μA
FLAG Delay Time	From fault condition to \overline{FLG} assertion		5	12	20	ms
Shutdown Pull-Low Resistance	$V_{EN}=0V, V_{\overline{EN}}=5V$ (not suited for A4772 no output discharge)		-	75	150	Ω
Under-Voltage Lockout	V_{IN} increasing		1.3	1.7	-	V
Under-Voltage Hysteresis	V_{IN} decreasing		-	0.1	-	V
Thermal Shutdown Protection			-	130	-	°C
Thermal Shutdown Hysteresis			-	20	-	°C

NOTE2: 100% production test at +25°C. Specifications over the temperature range are guaranteed by design and characterization. The device is not guaranteed to function outside its operating conditions.



TYPICAL PERFORMANCE CHARACTERISTICS

1. $R_{DS(on)}$ vs. V_{IN}

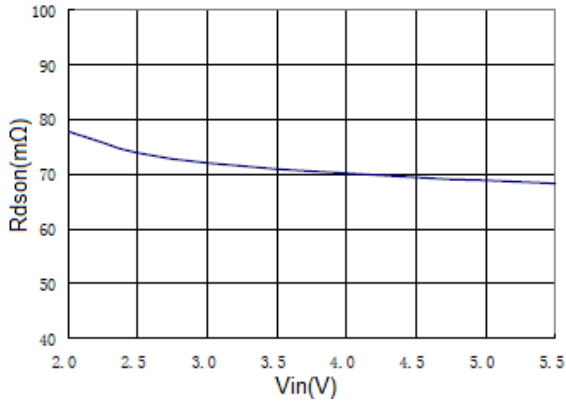

2. I_q vs. V_{IN}

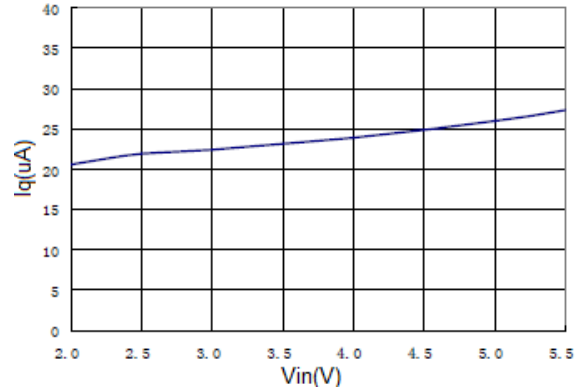

3. I_{limit} vs. V_{IN}

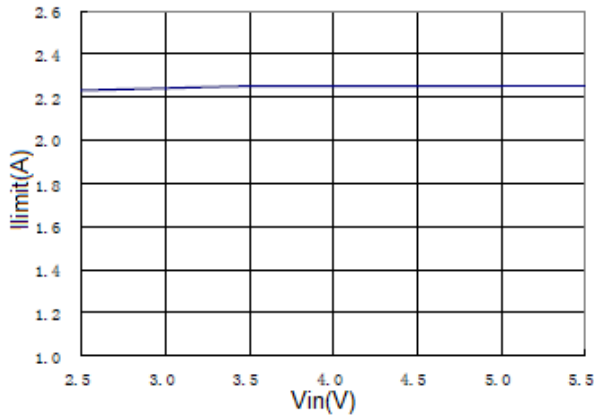

4. V_{OUT} vs. I_{OUT}

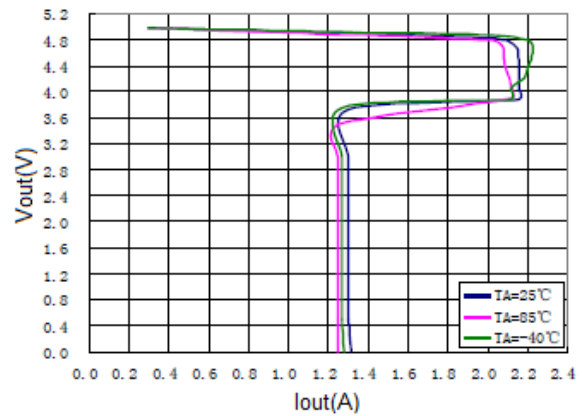

5. Short Circuit Fold-Back Current
CH1:VO, CH4:IO

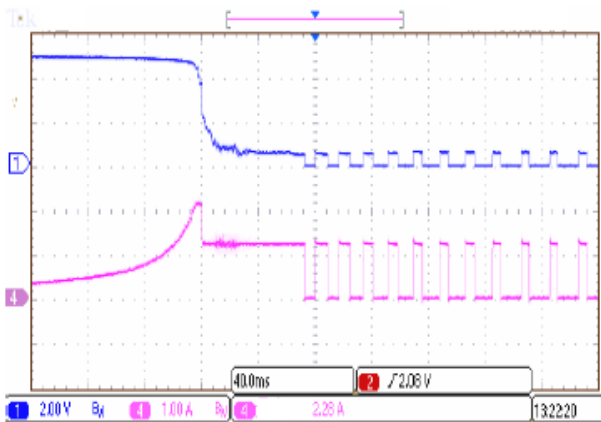

6. Flag Delay Time
CH1: FLAG, CH2:VO, CH4:IO

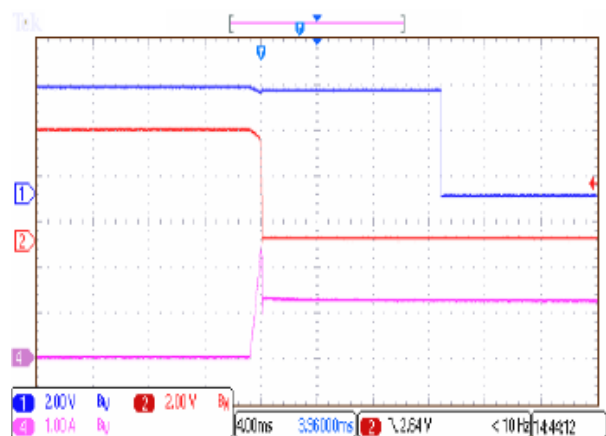



7. Turn On, CH1:EN, CH2:VO

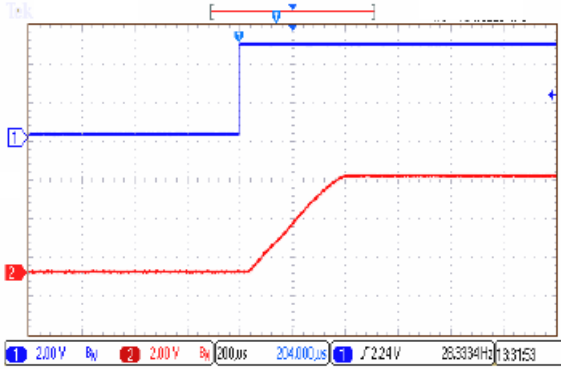

8. Turn Off, CH1:EN, CH2:VO

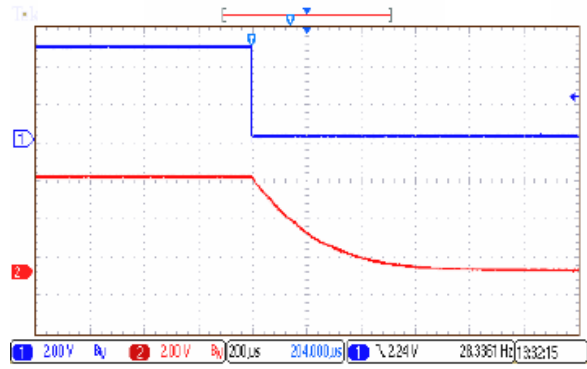

9. UVLO at Rising, CH1:VIN, CH2:VO

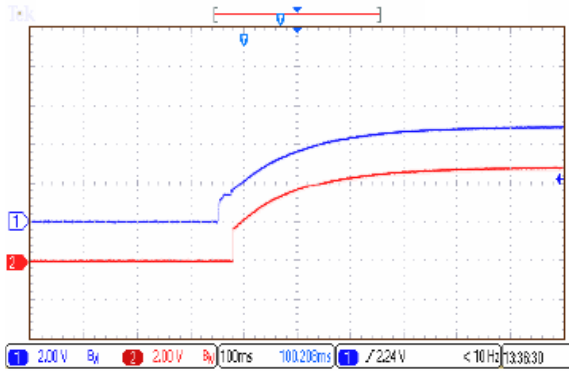

10. UVLO at Falling, CH1:VIN, CH2:VO

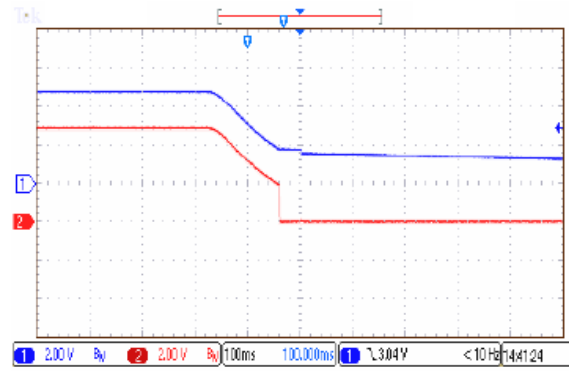



BLOCK DIAGRAM

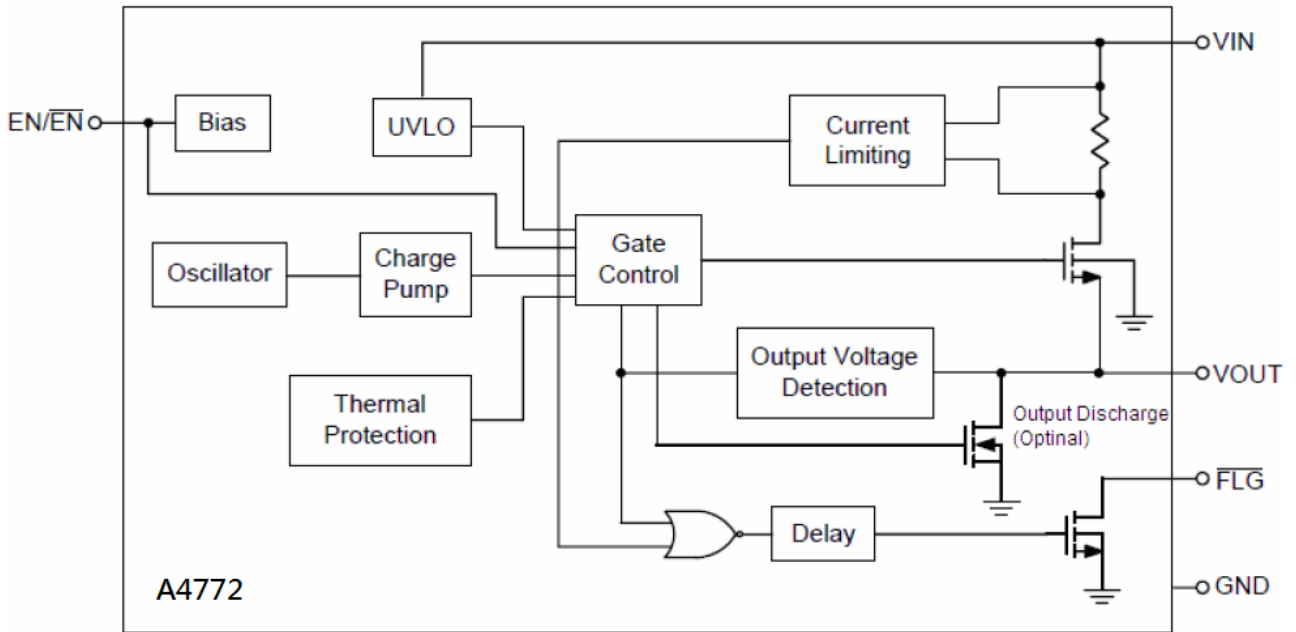



DETAILED INFORMATION

Applications Information

The A4772 are single N-MOSFET high-side power switches with enable input, optimized for self-powered and bus-powered Universal Serial Bus (USB) applications. The A4772 series are equipped with a charge pump circuitry to drive the internal N-MOSFET switch; the switch's low $R_{DS(ON)}$, 80mΩ, meets USB voltage drop requirements and a flag output is available to indicate fault conditions to the local USB controller.

Input and Output

V_{IN} (input) is the power source connection to the internal circuitry and the drain of the MOSFET. V_{OUT} (output) is the source of the MOSFET. In a typical application, current flows through the switch from V_{IN} to V_{OUT} toward the load. If V_{OUT} is greater than V_{IN} , current will flow from V_{OUT} to V_{IN} since the MOSFET is bidirectional when on.

Unlike a normal MOSFET, there is no a parasitic body diode between drain and source of the MOSFET, the A4772 prevents reverse current flow if V_{OUT} being externally forced to a higher voltage than V_{IN} when the output disabled ($V_{EN} < 0.8V$ or $V_{\overline{EN}} > 2V$).

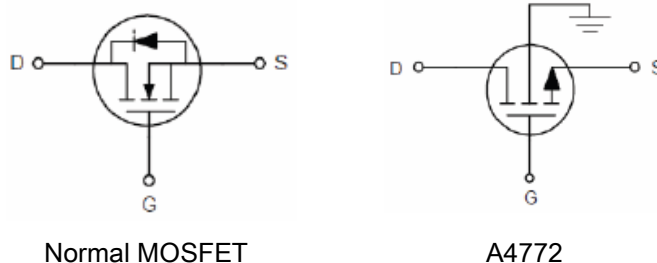

Enable

The switch will be disabled when the EN/\overline{EN} pin is in a logic low/high condition. During this condition, the internal circuitry and MOSFET are turned off, reducing the supply current to 0.1μA typical. Floating the EN/\overline{EN} pin may cause unpredictable operation. EN should not be allowed to go negative with respect to GND. The EN/\overline{EN} pin may be directly tied to V_{IN} (GND) to keep the part on.

UVLO

Under-voltage lockout (UVLO) prevents the MOSFET switch from turning on until input voltage exceeds approximately 1.7V. If input voltage drops below approximately 1.6V, UVLO turns off the MOSFET switch, \overline{FLG} will be asserted accordingly. Under-voltage detection functions only when the switch is enabled.



Soft Start for Hot Plug-In Applications

In order to eliminate the upstream voltage droop caused by the large inrush current during hot-plug events, the “soft-start” feature effectively isolates the power source from extremely large capacitive loads, satisfying the USB voltage droop requirements.

Fault Flag

The A4772 series provides a \overline{FLG} signal pin which is an N-Channel open drain MOSFET output. This open drain output goes low when $V_{OUT} < V_{IN} - 1V$, current limit or the die temperature exceeds 130°C approximately. The \overline{FLG} output is capable of sinking a 10mA load to typically 200mV above ground. The \overline{FLG} pin requires a pull-up resistor, this resistor should be large in value to reduce energy drain. A 100kΩ pull-up resistor works well for most applications. In the case of an over-current condition, \overline{FLG} will be asserted only after the flag response delay time, t_D , has elapsed. This ensures that \overline{FLG} is asserted only upon valid over-current conditions and that erroneous error reporting is eliminated.

Current Limiting and Short-Circuit Protection

The current limit circuitry prevents damage to the MOSFET switch and the hub downstream port but can deliver load current up to the current limit threshold of typically 2.1A/1.5A/1A/0.65A/2.5A through the switch of A4772A/B/C/D/E. When a heavy load or short circuit is applied to an enabled switch, a large transient current may flow until the current limit circuitry responds. Once this current limit threshold is exceeded the device enters constant current mode until the thermal shutdown occurs or the fault is removed.

Thermal Shutdown

Thermal shutdown is employed to protect the device from damage if the die temperature exceeds approximately 130°C. If enabled, the switch automatically restarts when the die temperature falls 20°C. The output and \overline{FLG} signal will continue to cycle on and off until the device is disabled or the fault is removed.

Input Capacitor

A 1μF low-ESR ceramic capacitor from V_{IN} to GND, located at the device is strongly recommended to prevent the input voltage drooping during hot-plug events. However, higher capacitor values will further reduce the voltage droop on the input. Furthermore, without the bypass capacitor, an output short may cause sufficient ringing on the input (from source lead inductance) to destroy the internal control circuitry. The input transient must not exceed 6.0V of the absolute maximum supply voltage even for a short duration.



Output Capacitor

A low-ESR 150uF aluminum electrolytic or tantalum between V_{OUT} and GND is strongly recommended to meet the 330mV maximum droop requirement in the hub V_{BUS} (Per USB 2.0, output ports must have a minimum 120uF of low-ESR bulk capacitance per hub). Standard bypass methods should be used to minimize inductance and resistance between the bypass capacitor and the downstream connector to reduce EMI and decouple voltage droop caused when downstream cables are hot-insertion transients. Ferrite beads in series with V_{BUS} , the ground line and the 0.1uF bypass capacitors at the power connector pins are recommended for EMI and ESD protection. The bypass capacitor itself should have a low dissipation factor to allow decoupling at higher frequencies.

Layout Considerations

For best performance of the A4772 series, the following guidelines must be strictly followed:

1. Input and output capacitors should be placed close to the IC and connected to ground plane to reduce noise coupling.
2. The GND should be connected to a strong ground plane for heat sink.
3. Keep the main current traces as possible as short and wide.



PACKAGE INFORMATION

Dimension in SOT-25 (Unit: mm)

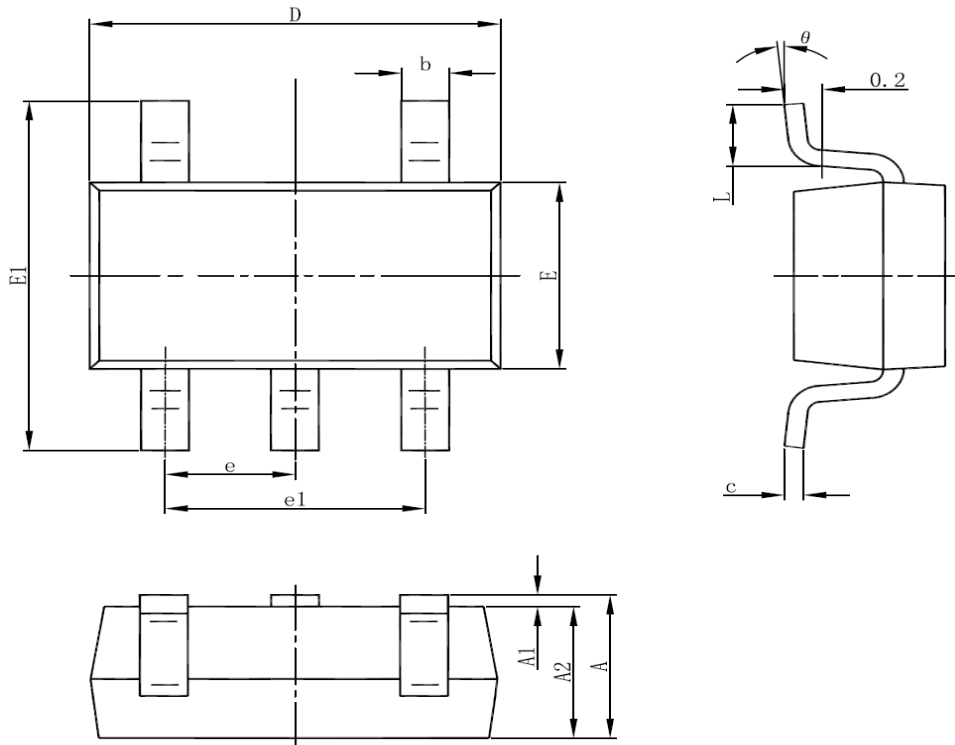

Symbol	Millimeters		Inches	
	Min	Max	Min	Max
A	1.050	1.250	0.041	0.049
A1	0.000	0.100	0.000	0.004
A2	1.050	1.150	0.041	0.045
b	0.300	0.500	0.012	0.020
c	0.100	0.200	0.004	0.008
D	2.820	3.020	0.111	0.119
E	1.500	1.700	0.059	0.067
E1	2.650	2.950	0.104	0.116
e	0.950(BSC)		0.037(BSC)	
e1	1.800	2.000	0.071	0.079
L	0.300	0.600	0.012	0.024
θ	0°	8°	0°	8°



IMPORTANT NOTICE

AiT Semiconductor Inc. (AiT) reserves the right to make changes to any its product, specifications, to discontinue any integrated circuit product or service without notice, and advises its customers to obtain the latest version of relevant information to verify, before placing orders, that the information being relied on is current.

AiT Semiconductor Inc.'s integrated circuit products are not designed, intended, authorized, or warranted to be suitable for use in life support applications, devices or systems or other critical applications. Use of AiT products in such applications is understood to be fully at the risk of the customer. As used herein may involve potential risks of death, personal injury, or server property, or environmental damage. In order to minimize risks associated with the customer's applications, the customer should provide adequate design and operating safeguards.

AiT Semiconductor Inc. assumes to no liability to customer product design or application support. AiT warrants the performance of its products of the specifications applicable at the time of sale.