



DESCRIPTION

A6500A series is a group of positive voltage output, low power consumption, low dropout voltage regulator.

A6500A can provide output value in the range of 1.0V~4.5V every 0.1V step. It also can be customized on command.

A6500A includes high accuracy voltage reference, error amplifier, current limit circuit and output driver module with discharge capability.

A6500A has excellent load and line transient response and good temperature characteristics, which can assure the stability of chip and power system. And it uses trimming technique to guarantee output voltage accuracy within $\pm 2\%$.

A6500A is available in SOT-25 package.

ORDERING INFORMATION

Package Type	Part Number	
SOT-25	E5	A6500AE5R-XXZ
		A6500AE5VR-XXZ
Note	XX: Output Voltage 25=2.5V, 33=3.3V Z: A, B (Pin Description) R: Tape & Reel V: Halogen free Package	
AiT provides all RoHS products Suffix " V " means Halogen free Package		

FEATURES

- Low Power Consumption: 30uA (Typ.)
- Low Output Noise (50uVRMS)
- Standby Mode: 0.1uA
- Low Dropout Voltage: 0.08V@ 150mA (Typ.)
- High Ripple Rejection: 72dB@ 1KHz (Typ.)
- Low Temperature Coefficient: $\pm 100\text{ppm}/^\circ\text{C}$
- Excellent Line Regulation: 0.05%/V
- Build-In chip enable and discharge circuit
- Output Voltage Range: 1.0V~4.5V (customized on command every 0.1V Step)
- Highly accurate: $\pm 2\%$
- Output Current Limit
- Available in SOT-25 Package

APPLICATION

- Power Source for Cellular Phones and various kind of PCs
- Battery Powered Equipment
- Power Management of MP3, PDA, DSC, Mouse, PS2 Games
- Reference Voltage Source
- Regulation after Switching Power

TYPICAL APPLICATION CIRCUIT

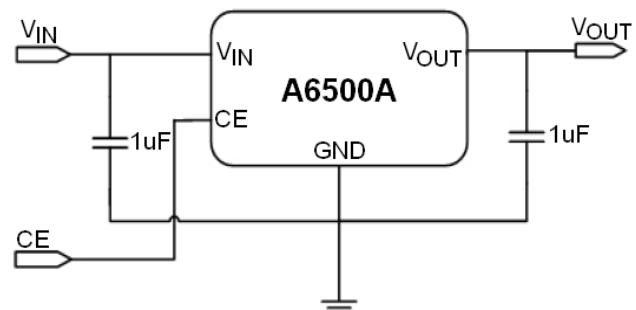

NOTE: Input capacitor ($C_{IN} = 1\mu\text{F}$) and Output capacitor ($C_{OUT} \geq 1\mu\text{F}$) are recommended in all application circuit.



PIN DESCRIPTION

<p style="text-align: center;">Top View</p>		<p style="text-align: center;">Top View</p>	
Pin #		Symbol	Function
SOT-25-XXA	SOT-25-XXB		
1	3	V_{IN}	Input voltage supply
2	2	V_{SS}	Ground
3	4	CE	Chip enable
4	5	NC	No connection
5	1	V_{OUT}	Output voltage



ABSOLUTE MAXIMUM RATINGS

Input Voltage	2V ~ 6V
T _J , Operation Junction Temperature	150°C
Output Current	600mA
Storage Temperature	-65°C ~ 150°C
Power Dissipation	SOT-25 360mW
IR Reflow Lead Temperature and Time	260°C, 10s
ESD Rating, Human Body Mode	3000V

Stresses above may cause permanent damage to the device. These are stress ratings only and functional operation of the device at these or any other conditions beyond those indicated in the Electrical Characteristics are not implied. Exposure to absolute maximum rating conditions for extended periods may affect device reliability.

RECOMMENDED OPERATION RANGE

Parameters	Value
Input Voltage	2V ~ 6V
Operation Ambient Temperature	-40°C ~ 85°C

THERMAL RESISTANCE

Package	θ_{JA}	θ_{JC}
SOT-25	250°C/W	130°C/W

NOTE: Thermal Resistance is specified with approximately 1 square of 1 oz copper.



ELECTRICAL CHARACTERISTICS

Test Condition: $C_{IN} = 1\mu F$, $C_{OUT} = 1\mu F$, $T_A = 25^\circ C$, unless otherwise specified.

Parameter	Symbol	Conditions	Min.	Typ.	Max.	Unit
Input Voltage	V_{IN}		2	-	6	V
Output Voltage	V_{OUT}	$V_{IN} = V_{OUTset} + 1V$ $1mA \leq I_{OUT} \leq 30mA$	V_{OUTset} $\times 0.98$	V_{OUTset}	V_{OUTset} $\times 1.02$	V
Maximum Output Current	I_{OUTMAX}		600	-	-	mA
Dropout Voltage $V_{OUT} \geq 2.8V$	V_{DROP}	$I_{OUT} = 50mA$	-	25	40	mV
		$I_{OUT} = 100mA$	-	50	75	
		$I_{OUT} = 150mA$	-	75	115	
		$I_{OUT} = 400mA$	-	220	280	
Line Regulation	$\frac{\Delta V_{OUT}}{\Delta V_{IN} \times V_{OUT}}$	$I_{OUT} = 40mA$ $2.8V \leq V_{IN} \leq 6V$	-	0.05	0.1	%/V
Load Regulation	$\frac{\Delta V_{OUT}}{\Delta I_{OUT}}$	$V_{IN} = V_{OUTset} + 1V$ $1mA \leq I_{OUT} \leq 500mA$	-	100	150	mV
Supply Current when Operation	I_{SS}	$V_{IN} = V_{OUTset} + 1V$	-	30	50	μA
Supply Current when Shut Down	$I_{shutdown}$	$V_{IN} = V_{OUTset} + 1V$ $V_{CE} = 0V$	-	0.1	1	μA
Output Voltage Temperature Coefficient	$\frac{\Delta V_{OUT}}{\Delta T \times V_{OUT}}$	$V_{IN} = Set V_{OUT} + 1V$ $I_{OUT} = 30mA$	-	± 50	-	ppm/ $^\circ C$
Power Supply Ripple Rejection Rate	PSRR	$F = 1KHz$ Ripple = 0.5Vpp $V_{IN} = V_{OUTset} + 1V$	-	72	-	dB
Output Short Current Limit	I_{LIMIT}	$V_{OUT} = 0V$	-	500	-	mA
CE Input Voltage "H"	V_{CEH}		1.4	-	-	V
CE Input Voltage "L"	V_{CEL}		-	-	0.25	V
Output Noise	e_n	Bandwith=10Hz~100KHz	-	50	-	μV_{RMS}

NOTE: V_{OUTset} is the nominal output voltage that A6500A is set to, for example, 3.3V.

$V_{DROP} = V_{IN} - (V_{OUT} \times 0.98)$, in which V_{OUT} is the output voltage when $V_{IN} = V_{OUTset} + 1.0V$ at different output current, and V_{IN} is the input voltage at which the output voltage becomes 98% of V_{OUT} after gradually decreasing the input voltage.



TYPICAL PERFORMANCE CHARACTERISTICS

Test Condition: $C_{IN}=1\mu F$, $C_{OUT}=1\mu F$, $T_A=25^\circ C$, CE pin is tied to V_{IN} , $V_{OUTset}=3.3V$, unless otherwise specified.

1. Output Voltage vs. Output Current

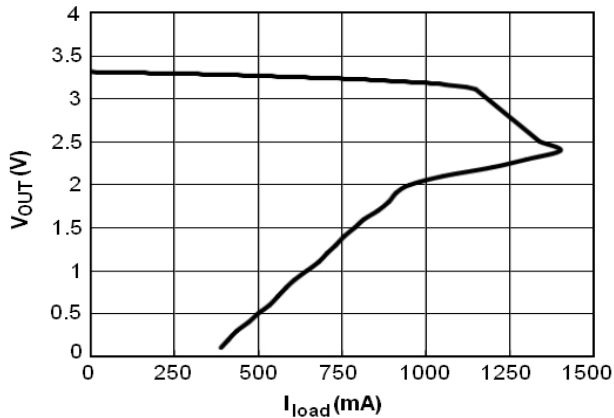

2. Output Voltage vs. Input Voltage

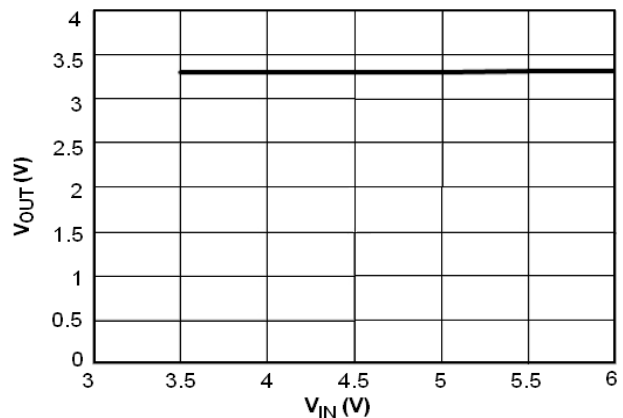

3. Dropout Voltage vs. Output Current

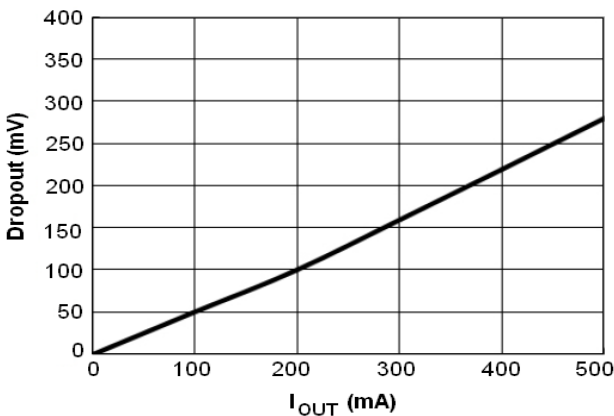

4. Ripple Rejection vs. Frequency

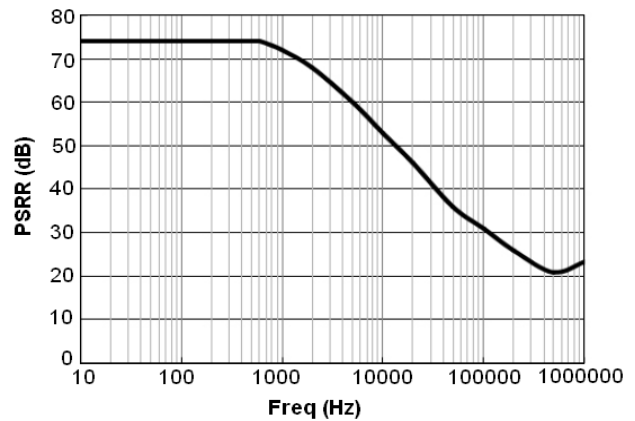

5. Line Transient Response (Ch1: V_{IN} 4 \rightarrow 5V; Ch2: V_{OUT})

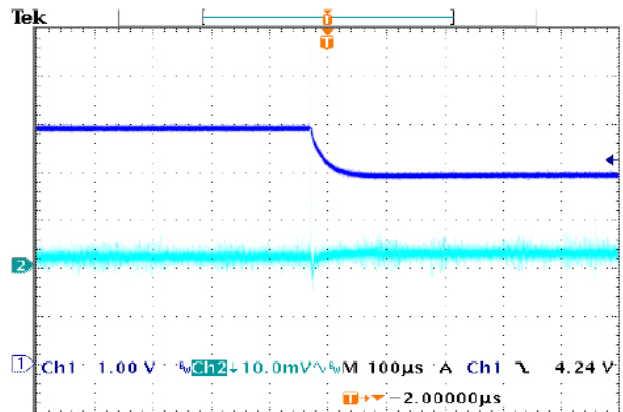
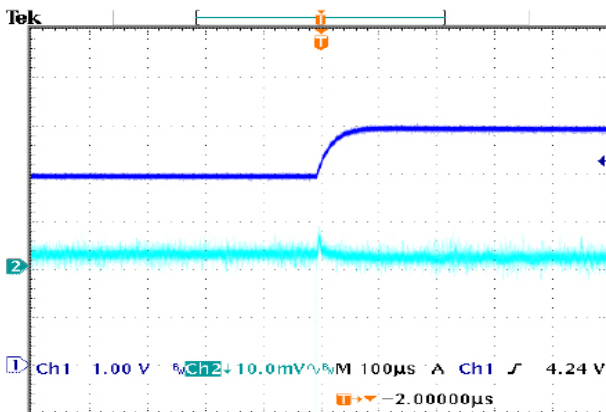



6. Load Transient Response (Ch1: I_{OUT} 1↔50mA; Ch2: V_{OUT})

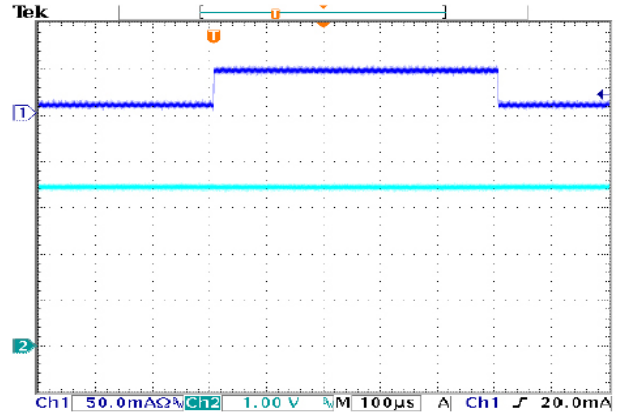
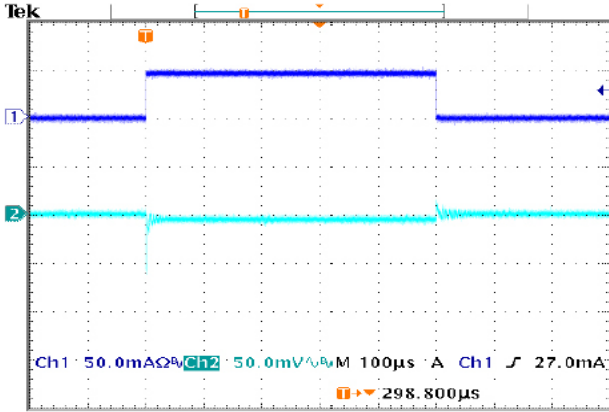

7. Startup by CE (Ch1: V_{OUT} ; Ch2: CE)

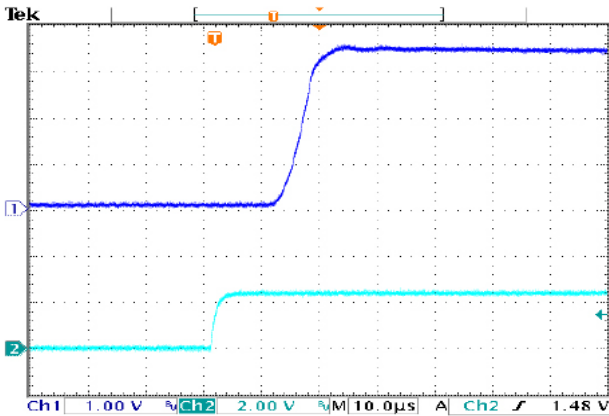

8. Shutdown by CE (Ch1: V_{OUT} ; Ch2: CE)

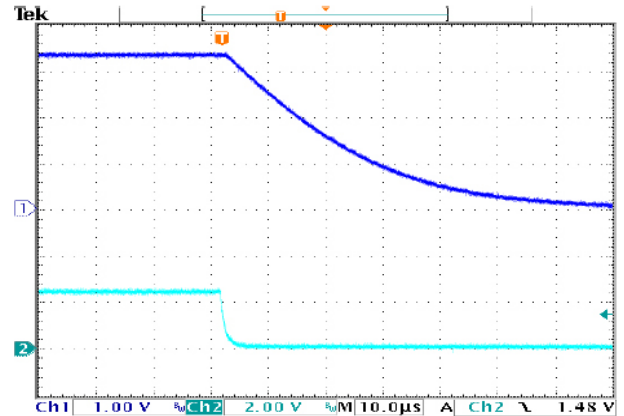

9. Load Regulation ($V_{IN} = 4.5V$, $V_{OUT} = 3.3V$)

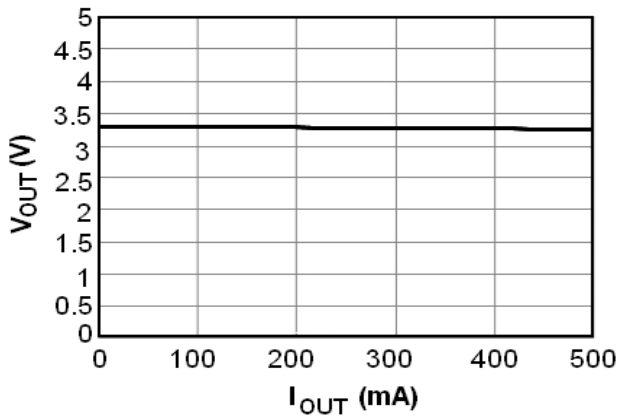



BLOCK DIAGRAM

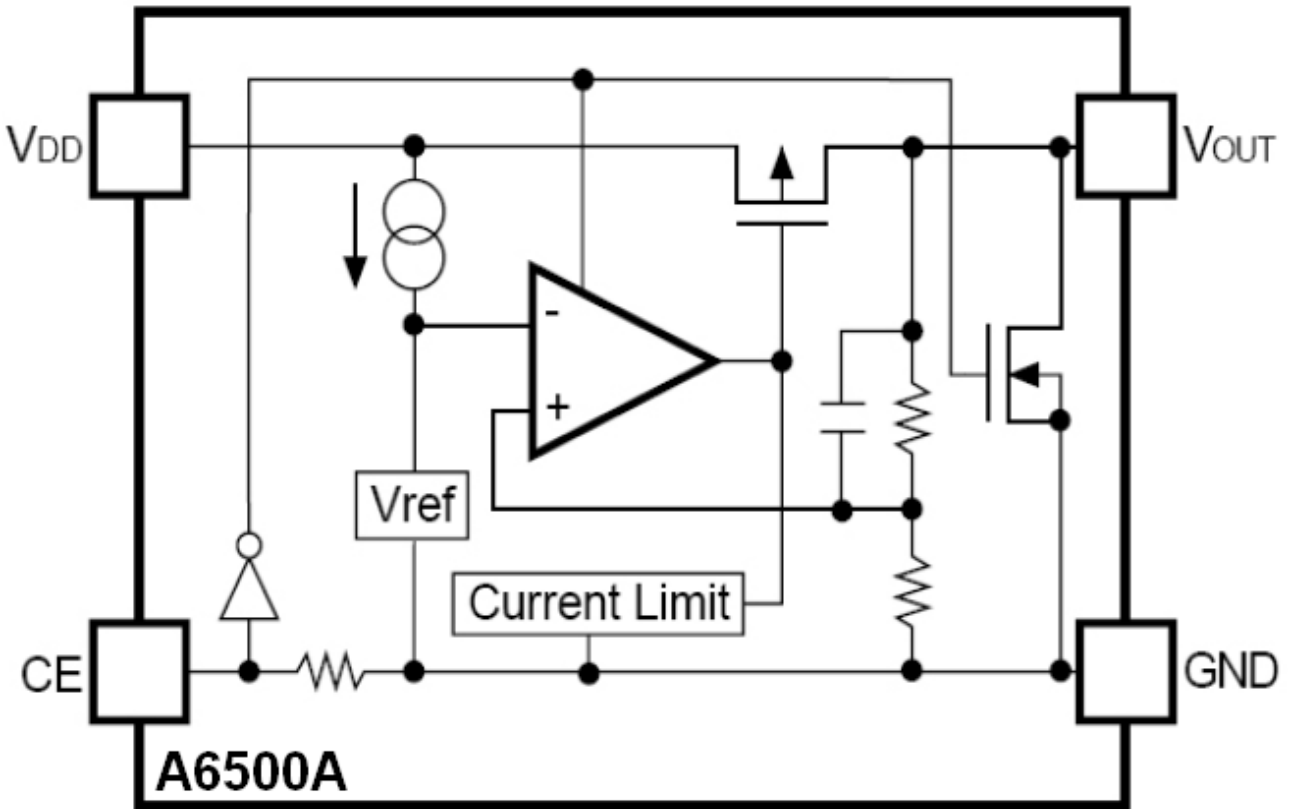



DETAILED INFORMATION

A6500A includes high accuracy voltage reference, error amplifier, current limit circuit and output driver module with discharge capability.

A6500A has excellent load and line transient response and good temperature characteristics, which can assure the stability of chip and power system. And it uses trimming technique to guarantee output voltage accuracy within $\pm 2\%$.

Low ESR ceramic capacitor can be used for A6500A for both input and output ends. Both 1uF can keep A6500A work stable. However, a larger output capacitor, such as 3.3uF/4.7uF is always recommended to compensate dynamic load current change.



PACKAGE INFORMATION

Dimension in SOT-25 (Unit: mm)

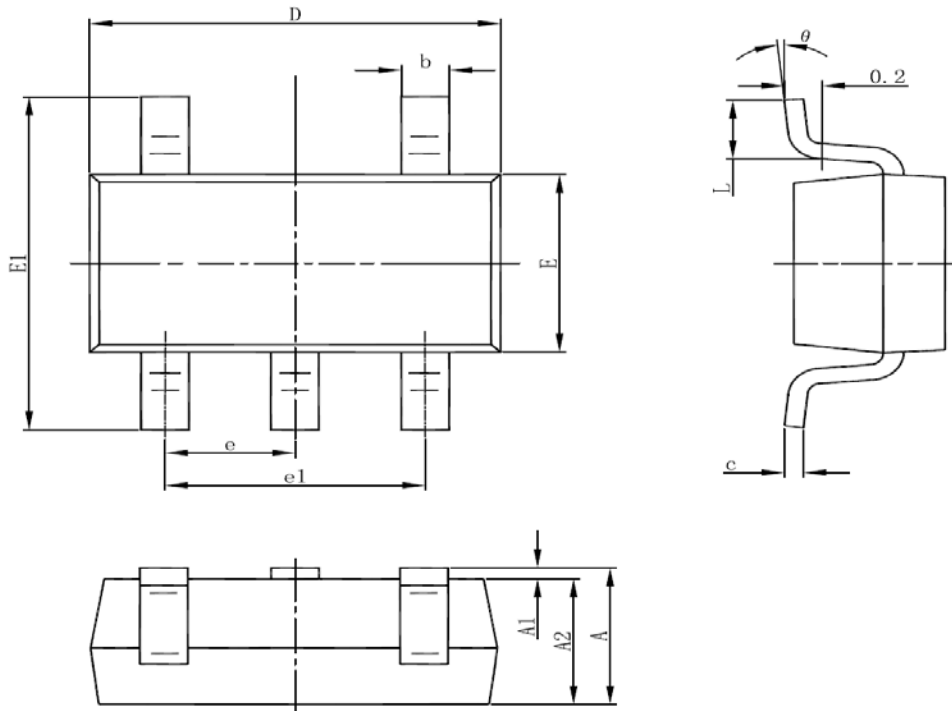

Symbol	Min	Max
A	1.000	1.300
A1	0.000	0.100
A2	1.000	1.200
b	0.300	0.500
c	0.100	0.250
D	2.700	3.100
E	1.500	1.800
E1	2.500	3.100
e	0.950(BSC)	
e1	1.700	2.100
L	0.200	-
θ	0°	8°



IMPORTANT NOTICE

AiT Semiconductor Inc. (AiT) reserves the right to make changes to any its product, specifications, to discontinue any integrated circuit product or service without notice, and advises its customers to obtain the latest version of relevant information to verify, before placing orders, that the information being relied on is current.

AiT Semiconductor Inc.'s integrated circuit products are not designed, intended, authorized, or warranted to be suitable for use in life support applications, devices or systems or other critical applications. Use of AiT products in such applications is understood to be fully at the risk of the customer. As used herein may involve potential risks of death, personal injury, or serve property, or environmental damage. In order to minimize risks associated with the customer's applications, the customer should provide adequate design and operating safeguards.

AiT Semiconductor Inc. assumes to no liability to customer product design or application support. AiT warrants the performance of its products of the specifications applicable at the time of sale.