



DESCRIPTION

The AM2307 is available in SOT-23S package.

ORDERING INFORMATION

Package Type	Part Number	
SOT-23S	E3S	AM2307E3SR
		AM2307E3SVR
Note	V: Halogen free Package R: Tape & Reel SPQ: 3,000pcs/Reel	
AiT provides all RoHS products Suffix " V " means Halogen free Package		

FEATURES

- -20V/-4.3A,
 $R_{DS(ON)} = 55m\Omega(MAX) @V_{GS} = -10V.$
 $R_{DS(ON)} = 70m\Omega(MAX) @V_{GS} = -4.5V.$
 $R_{DS(ON)} = 120m\Omega(MAX) @V_{GS} = -2.5V$
- Super High dense cell design for extremely low $R_{DS(ON)}$
- Reliable and Rugged
- Available in SOT-23S Package

APPLICATION

- Power Management
- Portable Equipment and Battery Powered Systems.

P CHANNEL MOSFET

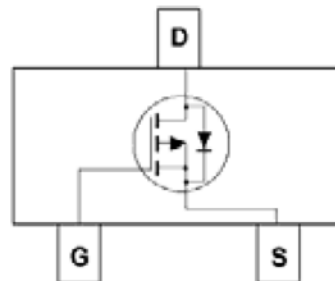



PIN DESCRIPTION

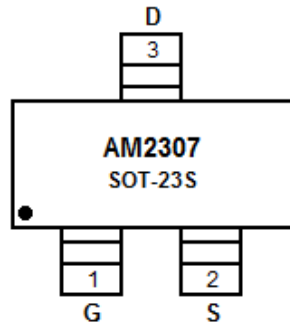

Top View

Pin #	Symbol	Function
1	G	Gate
2	S	Source
3	D	Drain



ABSOLUTE MAXIMUM RATINGS

T_A=25°C, unless otherwise noted

V _{DS} , Drain-Source Voltage	-20V
V _{GS} , Gate-Source Voltage	±12V
I _D , Drain Current-Continuous	-4.3A

Stresses above may cause permanent damage to the device. These are stress ratings only and functional operation of the device at these or any other conditions beyond those indicated in the Electrical Characteristics are not implied. Exposure to absolute maximum rating conditions for extended periods may affect device reliability.

ELECTRICAL CHARACTERISTICS

T_A=25°C, unless otherwise noted

Parameter	Symbol	Conditions	Min	Typ.	Max	Units
Off Characteristics						
Drain to Source Breakdown Voltage	B _{VDS}	V _{GS} =0V, I _D =-250μA	-20	-	-	V
Zero-Gate Voltage Drain Current	I _{DSS}	V _{DS} =-24V, V _{GS} =0V	-	-	-1	μA
Gate Body Leakage Current, Forward	I _{GSSF}	V _{GS} =12V, V _{DS} =0V	-	-	100	nA
Gate Body Leakage Current, Reverse	I _{GSSR}	V _{GS} =-12V, V _{DS} =0V	-	-	-100	nA
On Characteristics NOTE 3						
Gate Threshold Voltage	V _{GS(th)}	V _{GS} =V _{DS} , I _D =-250μA	-0.7	-	-1.3	V
Static Drain-Source On-Resistance	R _{DS(ON)}	V _{GS} =-10V, I _D =-4.2A	-	50	55	mΩ
		V _{GS} =-4.5V, I _D =-4.0A	-	60	70	
		V _{GS} =-2.5V, I _D =-1.0A	-	80	120	
Drain-Source Diode Characteristics and Maximum Ratings						
Drain-Source Diode Forward Voltage	V _{SD}	V _{GS} =0V, I _S =-1.0A	-	-	-1.0	V



TYPICAL PERFORMANCE CHARACTERISTICS

1. On-Region Characteristics

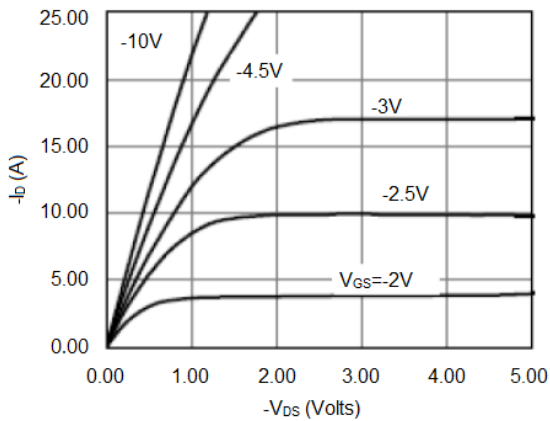

2. Transfer Characteristics

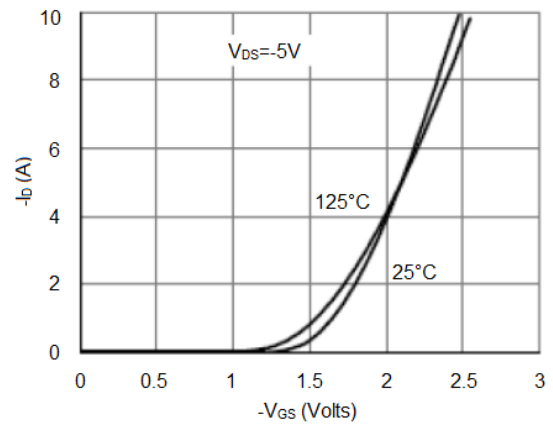

3. On-Resistance vs. Drain Current and Gate Voltage

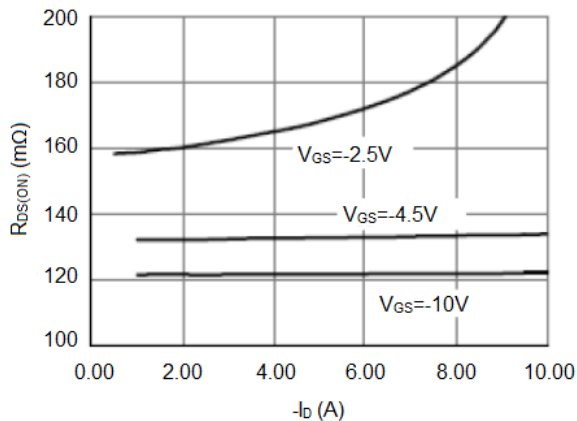

4. On-Resistance vs. Junction Temperature

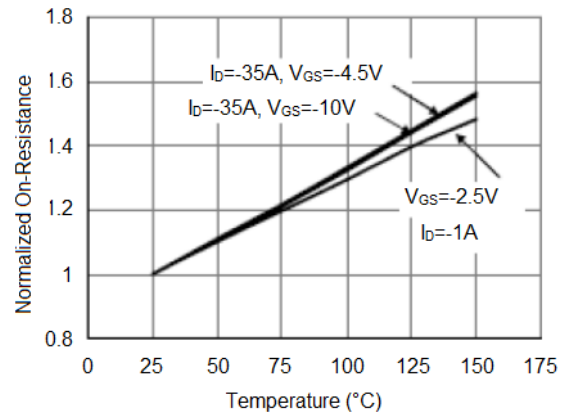

5. On-Resistance vs. Gate-Source Voltage

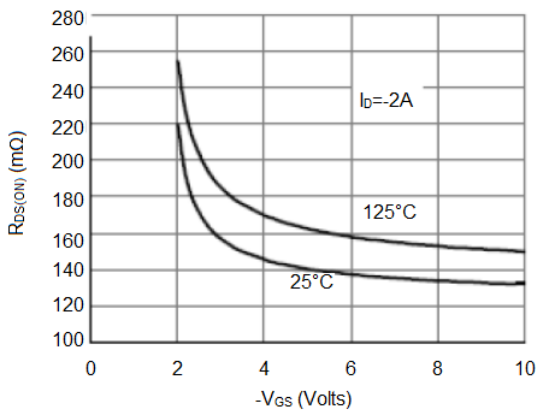

6. Body-Diode Characteristics

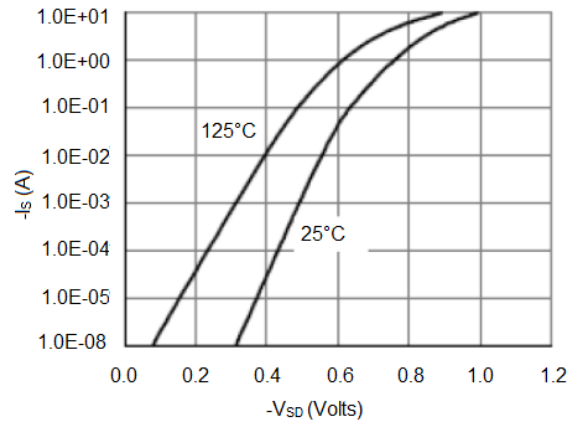



PACKAGE INFORMATION

Dimension in SOT-23S Package (Unit: mm)

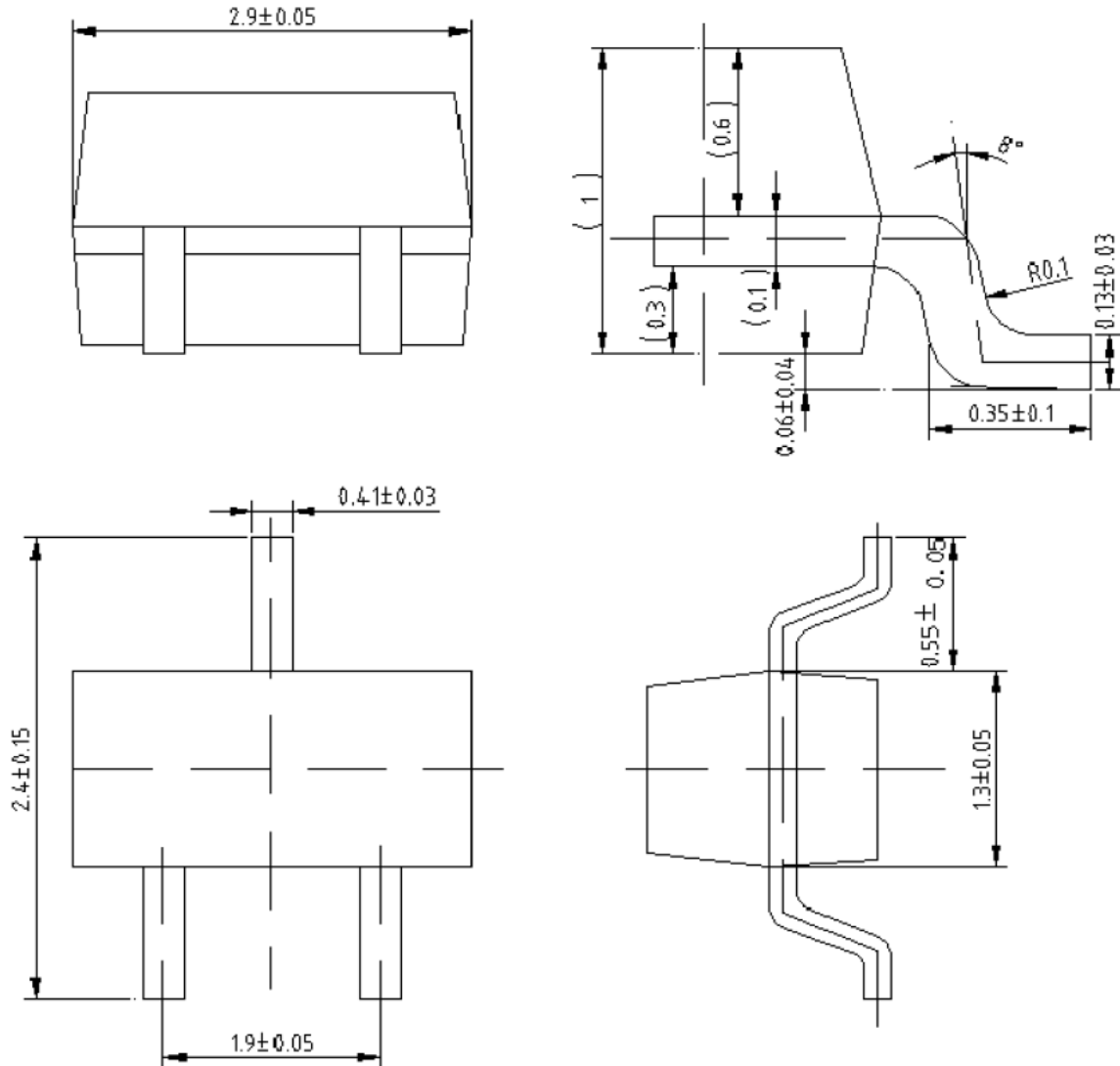



IMPORTANT NOTICE

AiT Semiconductor Inc. (AiT) reserves the right to make changes to any its product, specifications, to discontinue any integrated circuit product or service without notice, and advises its customers to obtain the latest version of relevant information to verify, before placing orders, that the information being relied on is current.

AiT Semiconductor Inc.'s integrated circuit products are not designed, intended, authorized, or warranted to be suitable for use in life support applications, devices or systems or other critical applications. Use of AiT products in such applications is understood to be fully at the risk of the customer. As used herein may involve potential risks of death, personal injury, or severe property, or environmental damage. In order to minimize risks associated with the customer's applications, the customer should provide adequate design and operating safeguards.

AiT Semiconductor Inc. assumes to no liability to customer product design or application support. AiT warrants the performance of its products of the specifications applicable at the time of sale.