



DESCRIPTION

The AM2309 is available in SOT-23S package.

FEATURES

- $V_{DS} = -20V$
 $R_{DS(ON)}, V_{GS}@-4.5V, I_{DS}@-2.8A} = 100m\Omega$
 $R_{DS(ON)}, V_{GS}@-2.5V, I_{DS}@-2.0A} = 150m\Omega$
- Advanced trench process technology
- High Density Cell Design For Ultra Low On-Resistance
- Fully Characterized Avalanche Voltage and Current
- Improved Shoot-Through FOM
- Simple Drive Requirement
- Small Package Outline
- Surface Mount Device
- Available in SOT-23S Package

ORDERING INFORMATION

Package Type	Part Number	
SOT-23S	E3S	AM2309E3SR
		AM2309E3SVR
Note	V: Halogen free Package R: Tape & Reel SPQ: 3,000pcs/Reel	
AiT provides all RoHS products Suffix " V " means Halogen free Package		

P CHANNEL MOSFET

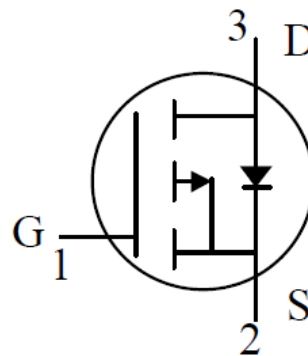



PIN DESCRIPTION

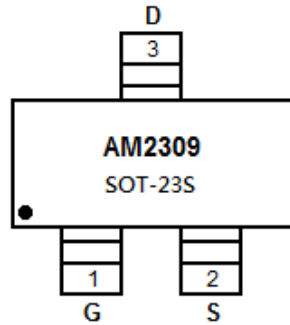

Top View

Pin #	Symbol	Function
1	G	Gate
2	S	Source
3	D	Drain

ABSOLUTE MAXIMUM RATINGS

T_A=25°C, unless otherwise noted

V _{DS} , Drain-Source Voltage	-20V	
V _{GS} , Gate-Source Voltage	±8V	
I _D , Continuous, Drain Current-	-2.3A	
I _{DM} , Pulsed Drain Current ^{NOTE1}	-8A	
P _D , Maximum Power Dissipation	T _A = 25°C	0.9W
	T _A = 75°C	0.57W
T _J , T _{STG} , Operating Junction and Storage Temperature Range	-55°C ~150°C	
R _{θJC} , Junction-to-Case Thermal Resistance		
R _{θJA} , Junction-to-Ambient Thermal Resistance (PCB mounted) ^{NOTE2}	140°C/W	

Stresses above may cause permanent damage to the device. These are stress ratings only and functional operation of the device at these or any other conditions beyond those indicated in the Electrical Characteristics are not implied. Exposure to absolute maximum rating conditions for extended periods may affect device reliability.

NOTE1: Repetitive Rating: Pulse width limited by the Maximum junction temperature.

NOTE2: 1-in² 2oz Cu PCB board

NOTE3: Guaranteed by design; not subject to production testing



ELECTRICAL CHARACTERISTICS

Parameter	Symbol	Conditions	Min.	Typ.	Max.	Unit
Static						
Drain-Source Breakdown Voltage	BV_{DSS}	$V_{GS}=0V, I_D=-250\mu A$	-20	-	-	V
Drain-Source On-State Resistance	$R_{DS(ON)}$	$V_{GS}=-4.5V, I_D=-2.8A$	-	69	100	mΩ
		$V_{GS}=-2.5V, I_D=-2.0A$	-	83	150	
Gate Threshold Voltage	$V_{GS(th)}$	$V_{DS}=V_{GS}, I_D=-250\mu A$	-0.45	-	-0.95	V
Zero Gate Voltage Drain Current	I_{DSS}	$V_{DS}=-9.6V, V_{GS}=0V$	-	-	-1	μA
Gate Body Leakage	I_{GSS}	$V_{GS}=\pm 8V, V_{DS}=0V$	-	-	±100	nA
Gate Resistance	R_g		-	-	-	Ω
Forward Transconductance	g_{FS}	$V_{DS}=-5V, I_D=-4.0A$	-	6.5	-	S
Dynamic NOTE 3						
Total Gate Charge	Q_g	$V_{DS}=-6V, I_D=-2.8A,$ $V_{GS}=-4.5V$	-	15.23	-	nC
Gate-Source Charge	Q_{gs}		-	5.49	-	
Gate-Drain Charge	Q_{gd}		-	2.74	-	
Turn-on Delay Time	$t_{d(on)}$	$V_{DD}=-6V, R_L=6\Omega$ $I_D = -1A, V_{GEN}=-4.5V,$ $R_G=6\Omega$	-	17.28	-	ns
Turn-on Rise Time	t_r		-	3.73	-	
Turn-Off Delay Time	$t_{d(off)}$		-	36.05	-	
Turn-Off Fall Time	t_f		-	6.19	-	
Input Capacitance	C_{iss}	$V_{DS}=-6V, V_{GS}=0V,$ $F=1.0MHz$	-	882.51	-	pF
Output Capacitance	C_{oss}		-	145.54	-	
Reverse Transfer Capacitance	C_{rss}		-	97.26	-	
Source-Drain Diode						
Max. Diode Forward Current	I_S		-	-	-2.4	A
Diode Forward Voltage	V_{SD}	$I_S=-0.75A, V_{GS}=0V$	-	-0.8	-1.2	V

NOTE: Pulse test: pulse width ≤ 300μs, duty cycle ≤ 2%



TYPICAL PERFORMANCE CHARACTERISTICS

1. Transfer Characteristics

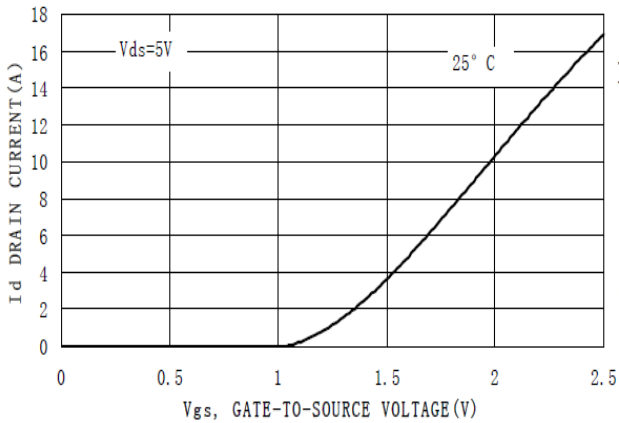

2. On-Region Characteristics

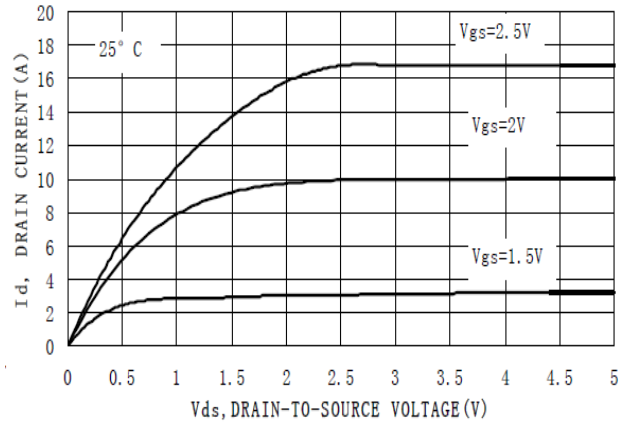

3. On-Resistance versus Drain Current

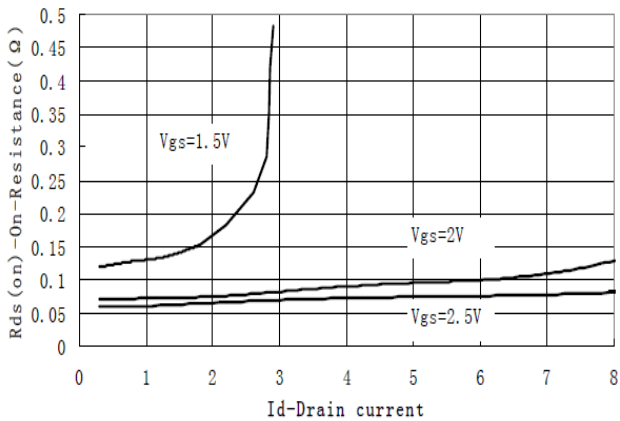

4. On-Resistance vs. Gate-to-Source Voltage

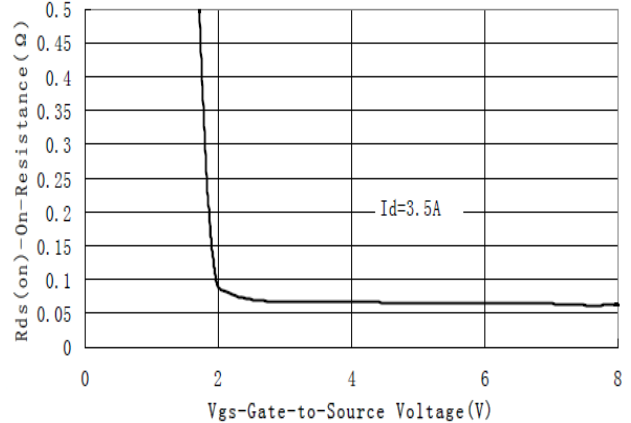

5. Gate Charge

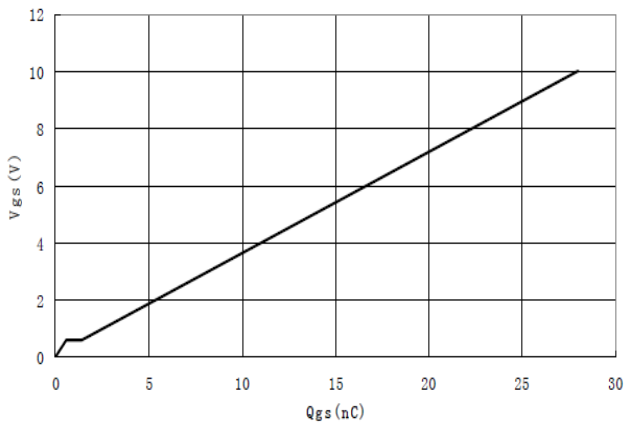

6. Capacitance

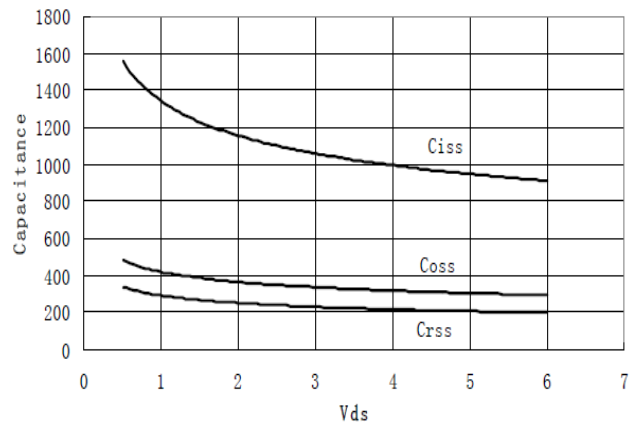



7. On-Resistance vs. Junction Temperature

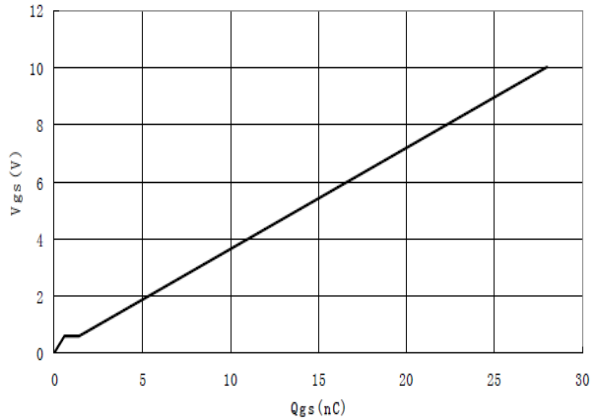

8. V_{GS(th)} vs. Junction Temperature

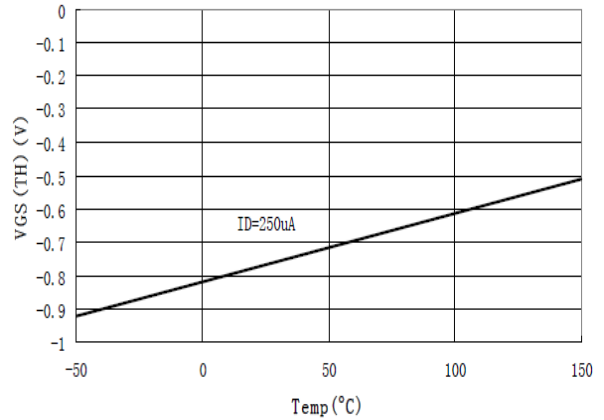

TYPICAL ELECTRICAL AND THERMAL CHARACTERISTICS

1. Switching Test Circuit

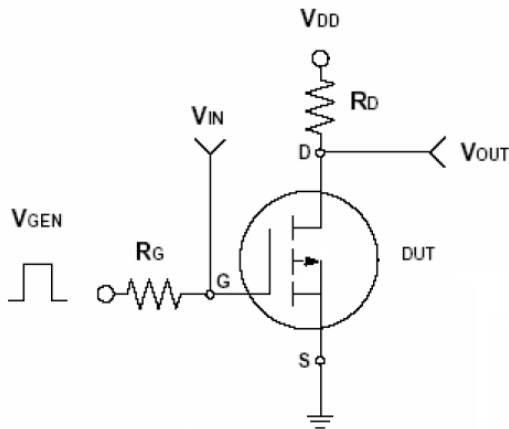

2. Switching Waveforms

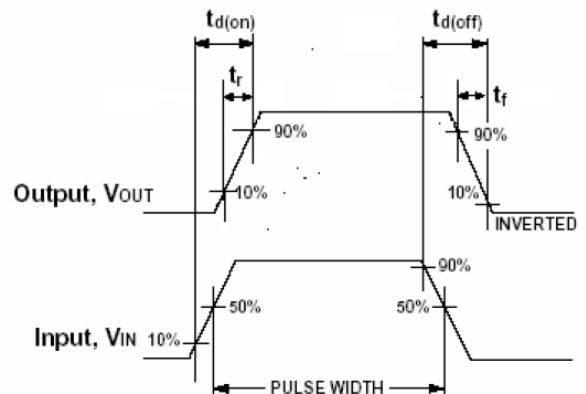



PACKAGE INFORMATION

Dimension in SOT-23S Package (Unit: mm)

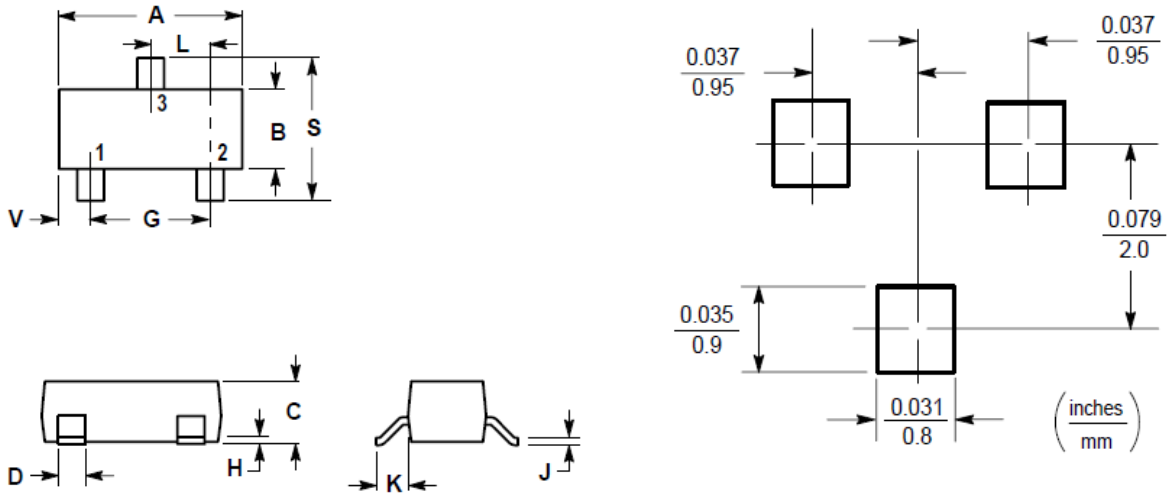

Symbol	Millimeters		Inches	
	Min	Max	Min	Max
A	2.80	3.04	0.1102	0.1197
B	1.20	1.40	0.0472	0.0551
C	0.89	1.11	0.0350	0.0440
D	0.37	0.50	0.0150	0.0200
G	1.78	2.04	0.0701	0.0807
H	0.013	0.100	0.0005	0.0040
J	0.085	0.177	0.0034	0.0070
K	0.35	0.69	0.0140	0.0285
L	0.89	1.02	0.0350	0.0401
S	2.10	2.64	0.0830	0.1039
V	0.45	0.60	0.0177	0.0236



IMPORTANT NOTICE

AiT Semiconductor Inc. (AiT) reserves the right to make changes to any its product, specifications, to discontinue any integrated circuit product or service without notice, and advises its customers to obtain the latest version of relevant information to verify, before placing orders, that the information being relied on is current.

AiT Semiconductor Inc.'s integrated circuit products are not designed, intended, authorized, or warranted to be suitable for use in life support applications, devices or systems or other critical applications. Use of AiT products in such applications is understood to be fully at the risk of the customer. As used herein may involve potential risks of death, personal injury, or severe property, or environmental damage. In order to minimize risks associated with the customer's applications, the customer should provide adequate design and operating safeguards.

AiT Semiconductor Inc. assumes to no liability to customer product design or application support. AiT warrants the performance of its products of the specifications applicable at the time of sale.