



DESCRIPTION

The AM3415 is the P-Channel logic enhancement mode power field effect transistor is produced using high cell density. Advanced trench technology to provide excellent $R_{DS(ON)}$ low gate charge and operation with gate voltage as 1.5V.

This device is suitable for use as a load switch or in applications.

The AM3415 is available in SOT-23 Package

ORDERING INFORMATION

Package Type	Part Number	
SOT-23	E3	AM3415E3R
		AM3415E3VR
Note	V: Halogen free Package R : Tape & Reel	
AiT provides all RoHS products Suffix " V " means Halogen free Package		

FEATURES

- -20V/-4.0A, $R_{DS(ON)} = 45m\Omega$ (typ.)@ $V_{GS} = -4.5V$
- -20V/-4.0A, $R_{DS(ON)} = 54m\Omega$ (typ.)@ $V_{GS} = -2.5V$
- -20V/-2.0A, $R_{DS(ON)} = 68m\Omega$ (typ.)@ $V_{GS} = -1.8V$
- -20V/-1.0A, $R_{DS(ON)} = 92m\Omega$ (typ.)@ $V_{GS} = -1.5V$
- Super high density cell design for extremely low $R_{DS(ON)}$
- Exceptional on-resistance and Maximum DC current capability
- ESD Protected : 3kV
- Available in SOT-23 package

APPLICATIONS

- Cellular/Portable
- Load Switch

P-CHANNEL MOSFET

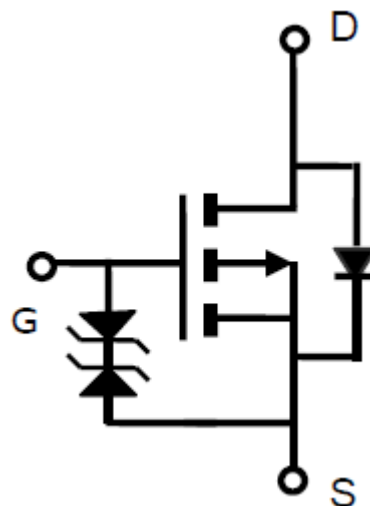



PIN DESCRIPTION

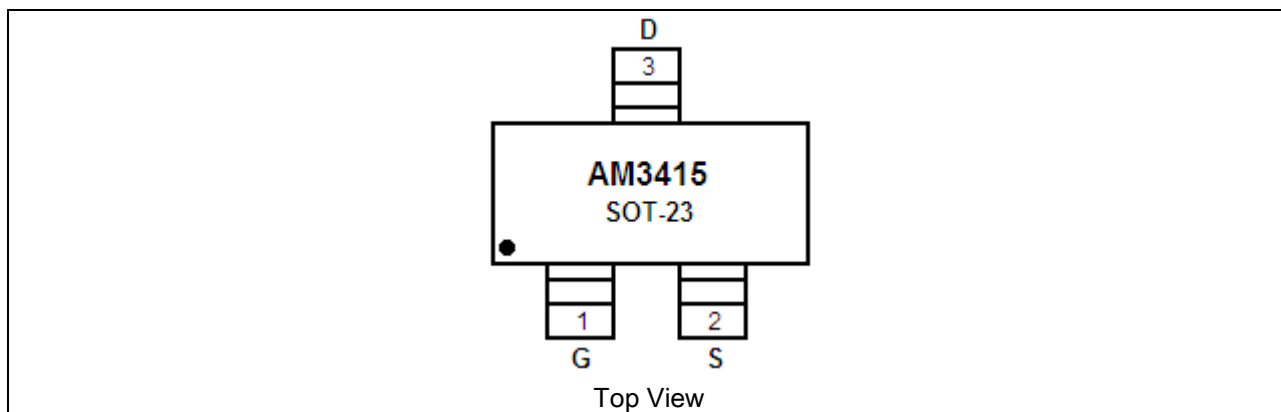

Pin #	Symbol	Function
1	G	Gate
2	S	Source
3	D	Drain



ABSOLUTE MAXIMUM RATINGS

T_A = 25°C, unless otherwise noted

V _{DSS} , Drain-Source Voltage		-20 V
V _{GSS} , Gate-Source Voltage		±8 V
I _D , Continuous Drain Current (V _{GS} =-8V)	T _A =25°C ^{NOTE1}	-4.0 A
	T _A =70°C ^{NOTE1}	-3.5 A
I _{DM} , Pulsed Drain Current ^{NOTE2}		-20 A
P _D , Power Dissipation	T _A =25°C	1.5 W
	T _A =70°C	0.9 W
T _J , Operation Junction Temperature		-55°C ~ 150°C
T _{STG} , Storage Temperature Range		55°C ~ 150°C

Stress beyond above listed "Absolute Maximum Ratings" may lead permanent damage to the device. These are stress ratings only and operations of the device at these or any other conditions beyond those indicated in the operational sections of the specifications are not implied. Exposure to absolute maximum rating conditions for extended periods may affect device reliability.

NOTE1: The value of R_{θJA} is measured with the device mounted on 1in 2 FR-4 board with 2oz. Copper, in a still air environment with T_A=25°C.

NOTE2: The data tested by pulsed , pulse width ≤ 300us , duty cycle ≤ 2%

THERMAL INFORMATION

Parameter	Symbol	Typ.	Max.	Units
Thermal Resistance-Junction to Ambient <small>Steady-State</small>	R _{θJA}	-	140	°C/W
Thermal Resistance Junction to Lead <small>Steady-State</small>	R _{θJL}	-	80	°C/W



ELECTRICAL CHARACTERISTICS

T_J = 25°C, unless otherwise specified

Parameter	Symbol	Conditions	Min	Type	Max	Units	
Static Parameters							
Drain-Source Breakdown Voltage	V _{(BR)DSS}	V _{GS} =0V, I _D =-250μA	-20	-	-	V	
Gate Threshold Voltage	V _{GS(th)}	V _{DS} =V _{GS} , I _D =-250μA	-0.3	-	-1.0	V	
Gate Leakage Current	I _{GSS}	V _{DS} =0V, V _{GS} =±8V	-	-	±10	μA	
Zero Gate Voltage, Drain-Source Leakage Current	I _{DSS}	V _{DS} =-20V, V _{GS} =0V T _J =25°C	-	-	-1	μA	
		V _{DS} =-20V, V _{GS} =0V T _J =55°C			-5		
Drain-source On-Resistance ^{NOTE2}	R _{DS(ON)}	V _{GS} =-4.5V, I _D =-4.0A	-	-	44	mΩ	
		V _{GS} =-2.5V, I _D =-4.0A			53		62
		V _{GS} =-1.8V, I _D =-2.0A			66		75
		V _{GS} =-1.5V, I _D =-1.0A			85		110
Forward Transconductance	g _{fs}	V _{DS} =-5V, I _D =-4.0A	-	22	-	S	
Source-Drain Diode							
Diode Forward Voltage	V _{SD}	I _S =-1.0A, V _{GS} =0V	-	-0.67	-1.0	V	
Continuous Source Current ^{NOTE1,3}	I _S		-	-	-6	A	
Dynamic Parameters							
Total Gate Charge	Q _g (-4.5V)	V _{DS} =-10V	-	11.1	-	nC	
Gate-Source Charge	Q _{gs}	V _{GS} =-4.5V					
Gate-Drain Charge	Q _{gd}	I _D =-4.0A					
Input Capacitance	C _{iss}	V _{DS} =-10V	-	989	-	pF	
Output Capacitance	C _{oss}	V _{GS} =0V					
Reverse Transfer Capacitance	C _{rss}	f=1MHz					
Turn-On Time	t _{d(on)}	V _{DD} =-10V	-	712	-	ns	
	t _r	I _D =-1A					
Turn-Off Time	t _{d(off)}	V _{GEN} =-4.5V	-	9.1	-	μs	
	t _f	R _G =2.5Ω					

NOTE1: The value of R_{θJA} is measured with the device mounted on 1 in 2 FR-4 board with 2oz. Copper, in a still air environment with T_A=25°C.

NOTE2: The data tested by pulsed, pulse width ≤ 300us, duty cycle ≤ 2%

NOTE3: The data is theoretically the same as I_D and I_{DM}, in real applications, should be limited by total power dissipation.



TYPICAL PERFORMANCE CHARACTERISTICS

$T_A=25^\circ\text{C}$, unless Specified

1. Output Characteristics

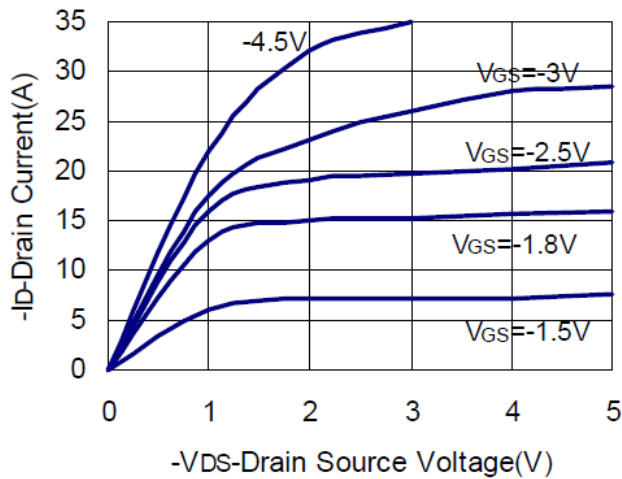

2. Drain-Source On Resistance

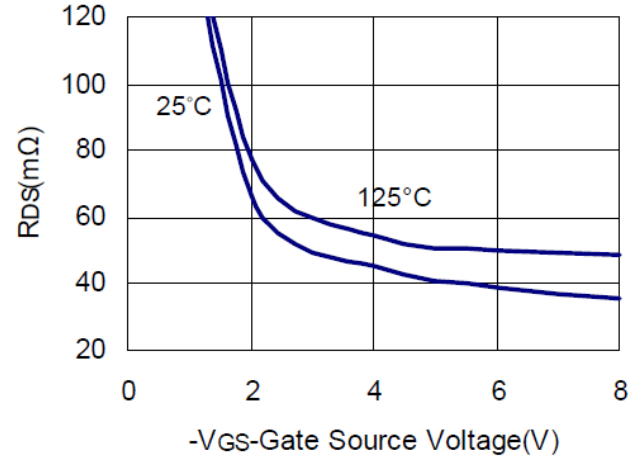

3. Drain Source On Resistance

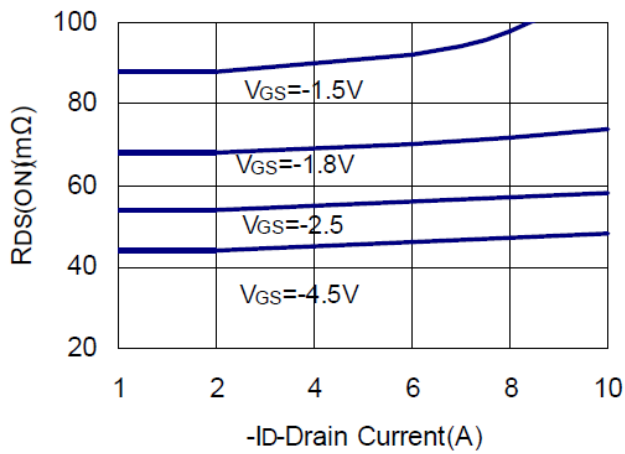

4. Transfer Characteristics

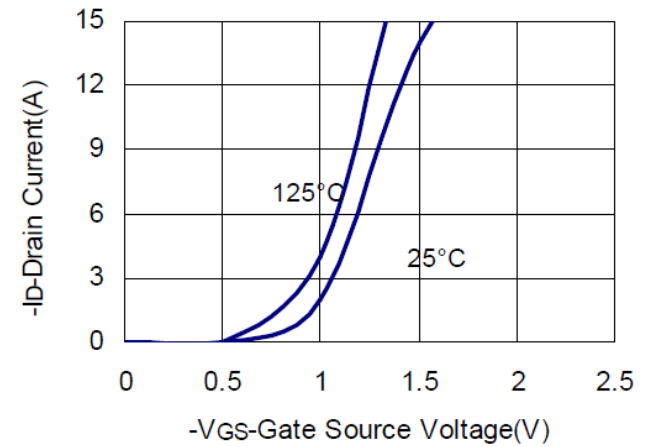

5. Gate Charge

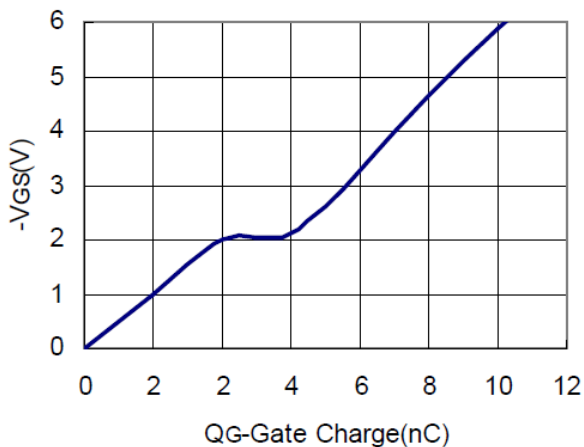

6. Drain Source Resistance

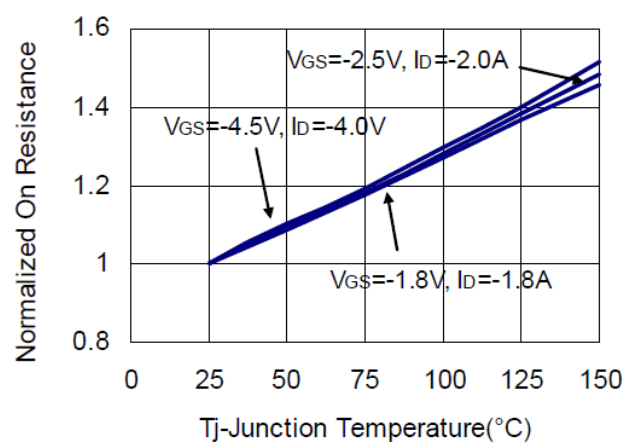



7. Capacitance

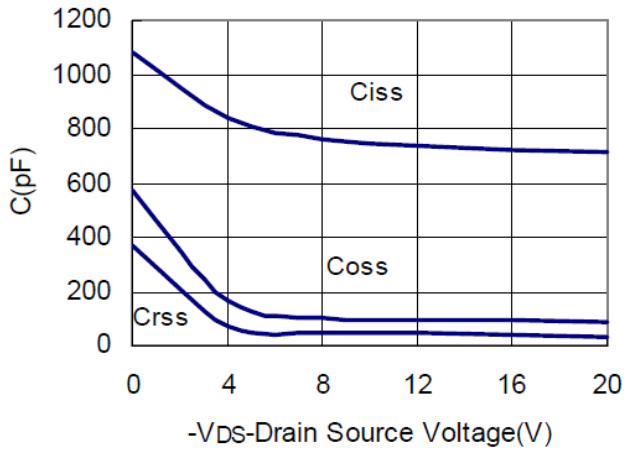

8. Source Drain Diode Forward

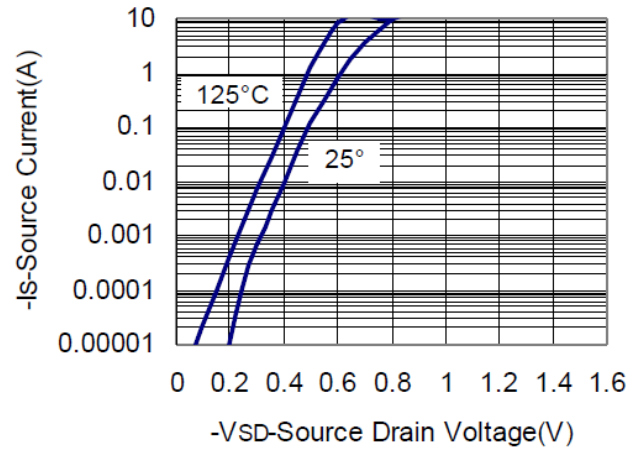

9. Power Dissipation

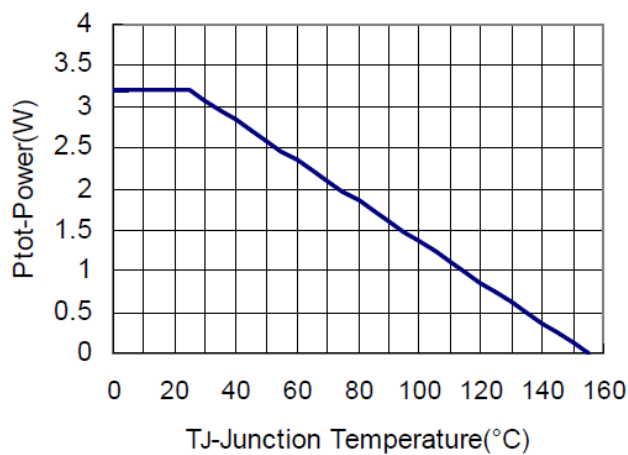

10. Drain Current

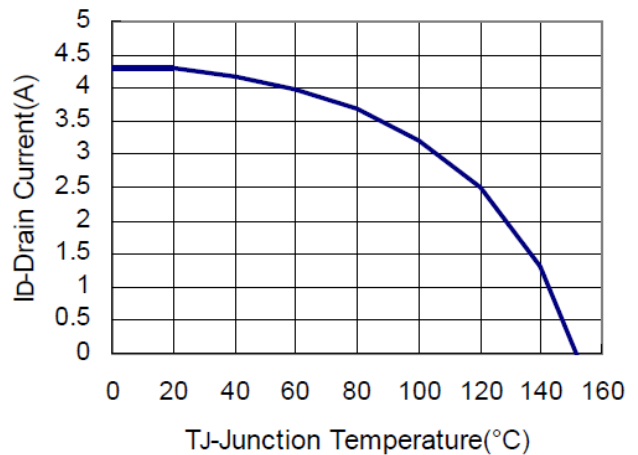

11. Thermal Transient Impedance

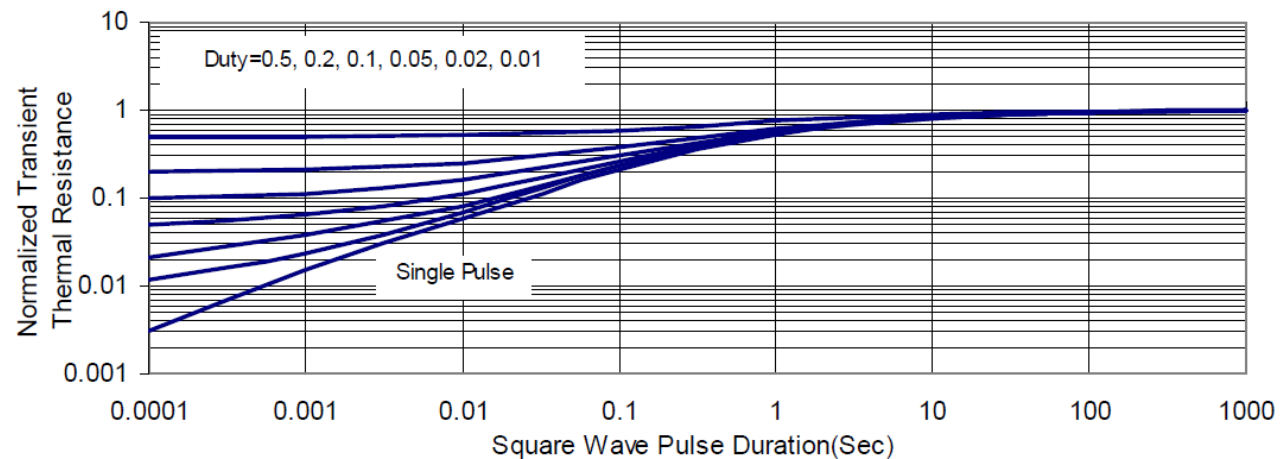



PACKAGE INFORMATION

Dimension in SOT-23 Package (Unit: mm)

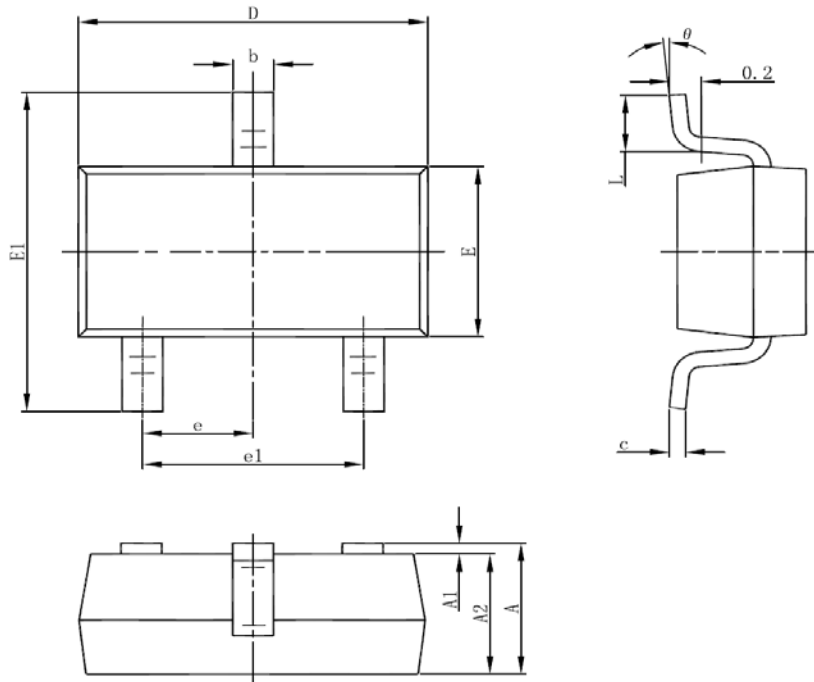

Symbol	Millimeters		Inches	
	Min	Max	Min	Max
A	1.05	1.25	0.041	0.049
A1	0.00	0.10	0.000	0.004
A2	1.05	1.15	0.041	0.045
b	0.30	0.50	0.012	0.020
c	0.10	0.20	0.004	0.008
D	2.82	3.02	0.111	0.119
E	1.50	1.70	0.059	0.067
E1	2.65	2.95	0.104	0.116
e	0.95(BSC)		0.037 (BSC)	
e1	1.80	2.00	0.071	0.079
L	0.30	0.60	0.012	0.024
θ	0°	8°	0°	8°



IMPORTANT NOTICE

AiT Semiconductor Inc. (AiT) reserves the right to make changes to any its product, specifications, to discontinue any integrated circuit product or service without notice, and advises its customers to obtain the latest version of relevant information to verify, before placing orders, that the information being relied on is current.

AiT Semiconductor Inc.'s integrated circuit products are not designed, intended, authorized, or warranted to be suitable for use in life support applications, devices or systems or other critical applications. Use of AiT products in such applications is understood to be fully at the risk of the customer. As used herein may involve potential risks of death, personal injury, or severe property, or environmental damage. In order to minimize risks associated with the customer's applications, the customer should provide adequate design and operating safeguards.

AiT Semiconductor Inc. assumes to no liability to customer product design or application support. AiT warrants the performance of its products of the specifications applicable at the time of sale.