



DESCRIPTION

The BZX84C2V4~BZX84C75 is available in SOT-23 Package

FEATURES

- Available in SOT-23 Package

ORDERING INFORMATION

Package Type	Part Number
SOT-23	BZX84C2V4
	BZX84C2V7
	BZX84C3V0
	BZX84C3V3
	BZX84C3V6
	BZX84C3V9
	BZX84C4V3
	BZX84C4V7
	BZX84C5V1
	BZX84C5V6
	BZX84C6V2
	BZX84C6V8
	BZX84C7V5
	BZX84C8V2
	BZX84C9V1
	BZX84C10
	BZX84C11
	BZX84C12
	BZX84C13
	BZX84C15
	BZX84C16
	BZX84C18
	BZX84C20
	BZX84C22
	BZX84C24
	BZX84C27
	BZX84C30
	BZX84C33
	BZX84C36
	BZX84C39
	BZX84C43
	BZX84C47
	BZX84C51
BZX84C56	
BZX84C62	
BZX84C68	
BZX84C75	
Note	SPQ: 3,000pcs/Reel
AiT provides all RoHS Compliant Products	

PIN DESCRIPTION

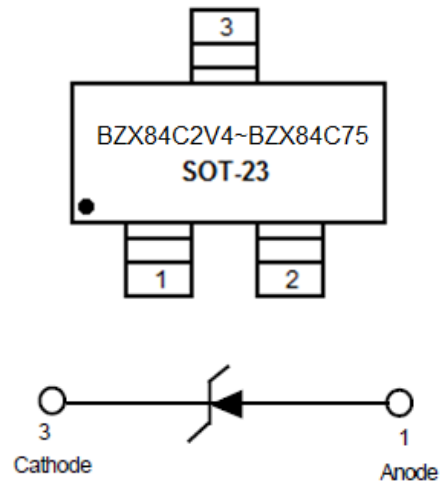



THERMAL CHARACTERISTICS

Parameter	Symbol	Max.	Unit
Total Device Dissipation FR-5 Board ^{NOTE1} $T_A = 25^\circ\text{C}$ Derate above 25°C	P_D	225 1.8	mW mW/ $^\circ\text{C}$
Thermal Resistance Junction to Ambient	R_{QJA}	556	$^\circ\text{C}/\text{W}$
Total Device Dissipation Alumina Substrate ^{NOTE2} $T_A = 25^\circ\text{C}$ Derate above 25°C	P_D	300 2.4	mW mW/ $^\circ\text{C}$
Thermal Resistance Junction to Ambient	R_{QJA}	417	$^\circ\text{C}/\text{W}$
Junction and Storage Temperature	T_J, T_{STG}	-55 to +125	$^\circ\text{C}$
Continous Forward Current	I_F	200	mA

NOTE1: FR-5 = 1.0 x 0.75 x 0.62 in.

NOTE2: Alumina = 0.4 x 0.3 x 0.024 in. 99.5% alumina.



ELECTRICAL CHARACTERISTICS

Pin out: 1-Anode, 2-No Connection, 3-Cathode, $T_A=25^\circ\text{C}$ unless otherwise noted, $V_F=0.90V_{MAX}$. @ $I_F=10\text{mA}$

Part Number*	V _{Z1} (Volts) @ I _{ZT1} =5mA (NOTE3)			Z _{ZT1} (Ω) @ I _{ZT1} =5mA	V _{Z2} (V) @ I _{ZT2} =1mA (NOTE3)		Z _{ZT2} (Ω) @ I _{ZT2} =1mA	V _{Z3} (V) @ I _{ZT3} =20mA (NOTE3)		Z _{ZT3} (Ω) @ I _{ZT3} =20mA	Max Reverse Leakage Current		θ _{vz} (mV/k) @ I _{ZT1} =5mA		C (pF) @V _R =0 f=1MHz
	Min	Nom	Max		Min	Max		Min	Max		I _R μA	V _R Volts	Min	Max	
	BZX84C2V4	2.2	2.4	2.6	100	1.7	2.1	600	2.6	3.2	50	50	1	-3.5	0
BZX84C2V7	2.5	2.7	2.9	100	1.9	2.4	600	3	3.6	50	20	1	-3.5	0	450
BZX84C3V0	2.8	3	3.2	95	2.1	2.7	600	3.3	3.9	50	10	1	-3.5	0	450
BZX84C3V3	3.1	3.3	3.5	95	2.3	2.9	600	3.6	4.2	40	5	1	-3.5	0	450
BZX84C3V6	3.4	3.6	3.8	90	2.7	3.3	600	3.9	4.5	40	5	1	-3.5	0	450
BZX84C3V9	3.7	3.9	4.1	90	2.9	3.5	600	4.1	4.7	30	3	1	-3.5	-2.5	450
BZX84C4V3	4	4.3	4.6	90	3.3	4	600	4.4	5.1	30	3	1	-3.5	0	450
BZX84C4V7	4.4	4.7	5	80	3.7	4.7	500	4.5	5.4	15	3	2	-3.5	0.2	260
BZX84C5V1	4.8	5.1	5.4	60	4.2	5.3	480	5	5.9	15	2	2	-2.7	1.2	225
BZX84C5V6	5.2	5.6	6	40	4.8	6	400	5.2	6.3	10	1	2	-2.0	2.5	200
BZX84C6V2	5.8	6.2	6.6	10	5.6	6.6	150	5.8	6.8	6	3	4	0.4	3.7	185
BZX84C6V8	6.4	6.8	7.2	15	6.3	7.2	80	6.4	7.4	6	2	4	1.2	4.5	155
BZX84C7V5	7	7.5	7.9	15	6.9	7.9	80	7	8	6	1	5	2.5	5.3	140
BZX84C8V2	7.7	8.2	8.7	15	7.6	8.7	80	7.7	8.8	6	0.7	5	3.2	6.2	135
BZX84C9V1	8.5	9.1	9.6	15	8.4	9.6	100	8.5	9.7	8	0.5	6	3.8	7.0	130
BZX84C10	9.4	10	10.6	20	9.3	10.6	150	9.4	10.7	10	0.2	7	4.5	8.0	130
BZX84C11	10.4	11	11.6	20	10.2	11.6	150	10.4	11.8	10	0.1	8	5.4	9.0	130
BZX84C12	11.4	12	12.7	25	11.2	12.7	150	11.4	12.9	10	0.1	8	6.0	10.0	130
BZX84C13	12.4	13	14.1	30	12.3	14	170	12.5	14.2	15	0.1	8	7.0	11.0	120
BZX84C15	13.8	15	15.6	30	13.7	15.5	200	13.9	15.7	20	0.05	10.5	9.2	13.0	110
BZX84C16	15.3	16	17.1	40	15.2	17	200	15.4	17.2	20	0.05	11.2	10.4	14.0	105
BZX84C18	16.8	18	19.1	45	16.7	19	225	16.9	19.2	20	0.05	12.6	12.4	16.0	100
BZX84C20	18.8	20	21.2	55	18.7	21.1	225	18.9	21.4	20	0.05	14	14.4	18.0	85
BZX84C22	20.8	22	23.3	55	20.7	23.2	250	20.9	23.4	25	0.05	15.4	16.4	20.0	85
BZX84C24	22.8	24	25.6	70	22.7	25.5	250	22.9	25.7	25	0.05	16.8	18.4	22.0	80



Part Number	V _{Z1} Below @ I _{ZT1} =2mA			Z _{ZT1} Below @ I _{ZT1} =2mA	V _{Z2} Below @ I _{ZT2} =0.1mA		Z _{ZT2} Below @ I _{ZT4} =0.5mA	V _{Z3} Below @ I _{ZT3} =10mA		Z _{ZT3} Below @ I _{ZT3} =10mA	Max Reverse Leakage Current		θ _{vz} (mV/k) Below @ I _{ZT1} =2mA		C (pF) @ V _R =0 f=1MHz
	Min	Nom	Max		Min	Max		Min	Max		I _R μA @	V _R (V)	Min	Max	
													A		
BZX84C27	25.1	27	28.9	80	25	28.9	300	25.2	29.3	45	0.05	18.9	21.4	25.3	70
BZX84C30	28	30	32	80	27.8	32	300	28.1	32.4	50	0.05	21	24.4	29.4	70
BZX84C33	31	33	35	80	30.8	35	325	31.1	35.4	55	0.05	23.1	27.4	33.4	70
BZX84C36	34	36	38	90	33.8	38	350	34.1	38.4	60	0.05	25.2	30.4	37.4	70
BZX84C39	37	39	41	130	36.7	41	350	37.1	41.5	70	0.05	27.3	33.4	41.2	45
BZX84C43	40	43	46	150	39.7	46	375	40.1	46.5	80	0.05	30.1	37.6	46.6	40
BZX84C47	44	47	50	170	43.7	50	375	44.1	50.5	90	0.05	32.9	42.0	51.8	40
BZX84C51	48	51	54	180	47.6	54	400	48.1	54.6	100	0.05	35.7	46.6	57.2	40
BZX84C56	52	56	60	200	51.5	60	425	52.1	60.8	110	0.05	39.2	52.2	63.8	40
BZX84C62	58	62	66	215	57.4	66	450	58.2	67	120	0.05	43.4	58.8	71.6	35
BZX84C68	64	68	72	240	63.4	72	475	64.2	73.2	130	0.05	47.6	65.6	79.8	35
BZX84C75	70	75	79	255	69.4	79	500	70.3	80.2	140	0.05	52.5	73.4	88.6	35

NOTE3: Zener voltage is measured with a pulse test current I_Z at an ambient temperature of 25°C.



TYPICAL CHARACTERISTICS

Figure 1. Temperature Coefficients
(Temperature Range -55°C to $+150^{\circ}\text{C}$)

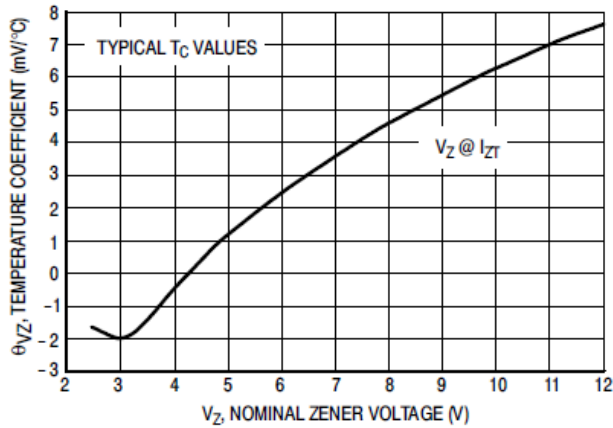

Figure 2. Temperature Coefficients
(Temperature Range -55°C to $+150^{\circ}\text{C}$)

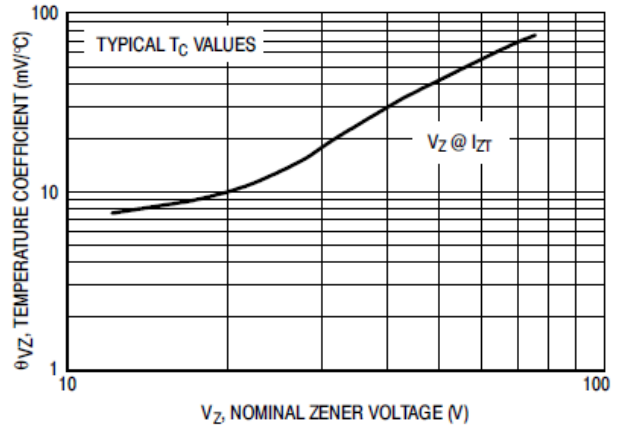

Figure 3. Effect of Zener Voltage on Zener Impedance

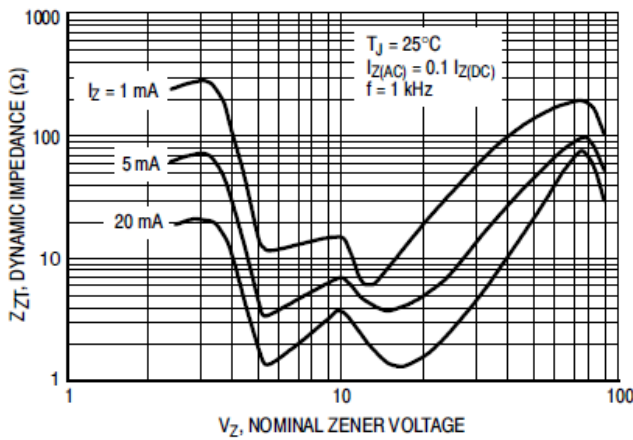

Figure 4. Typical Forward Voltage

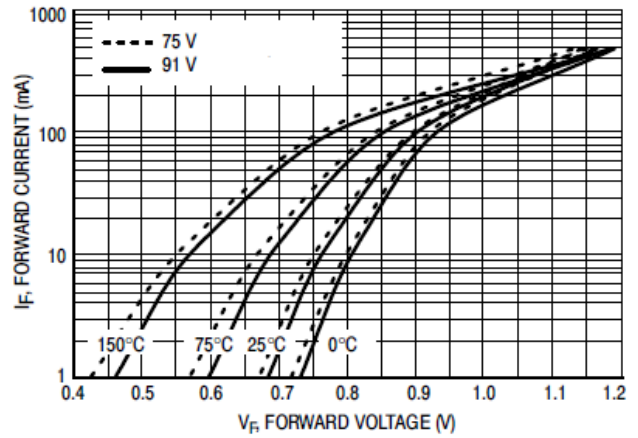



Figure 5. Typical Capacitance

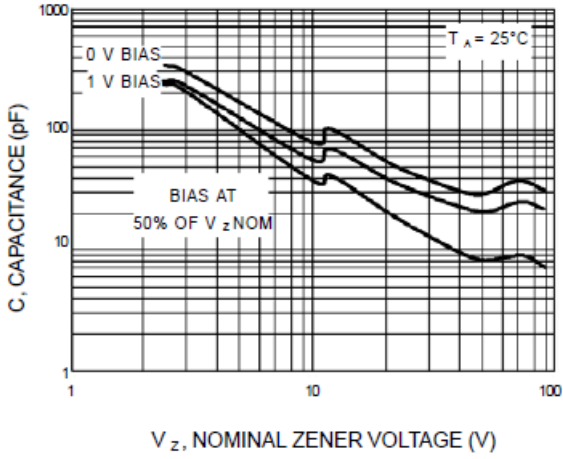

Figure 6. Typical Leakage Current

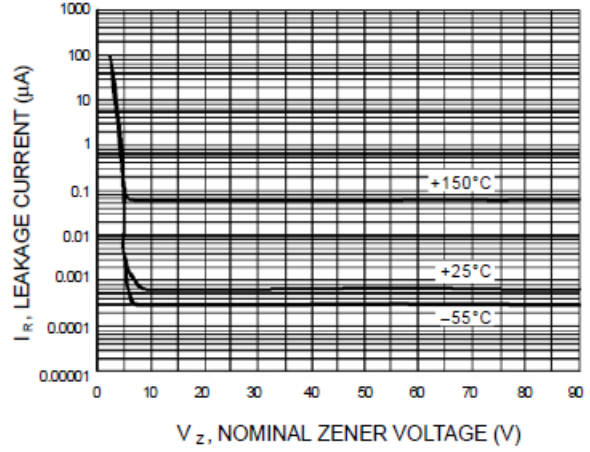

Figure 7. Zener Voltage versus Zener Current
(V_z Up to 12V)

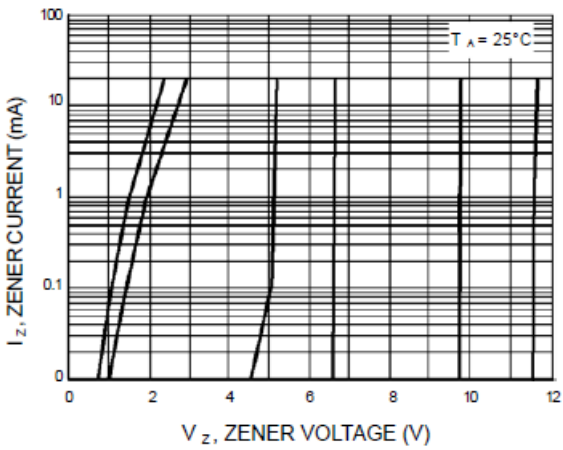
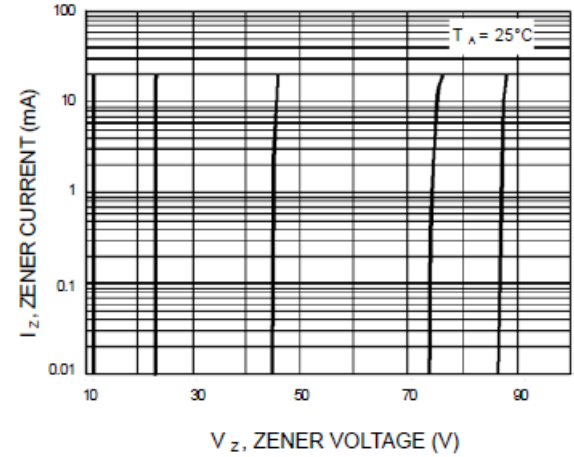

Figure 8. Zener Voltage versus Zener Current
(12V to 91V)





PACKAGE INFORMATION

Dimension in SOT-23 Package (Unit: mm)

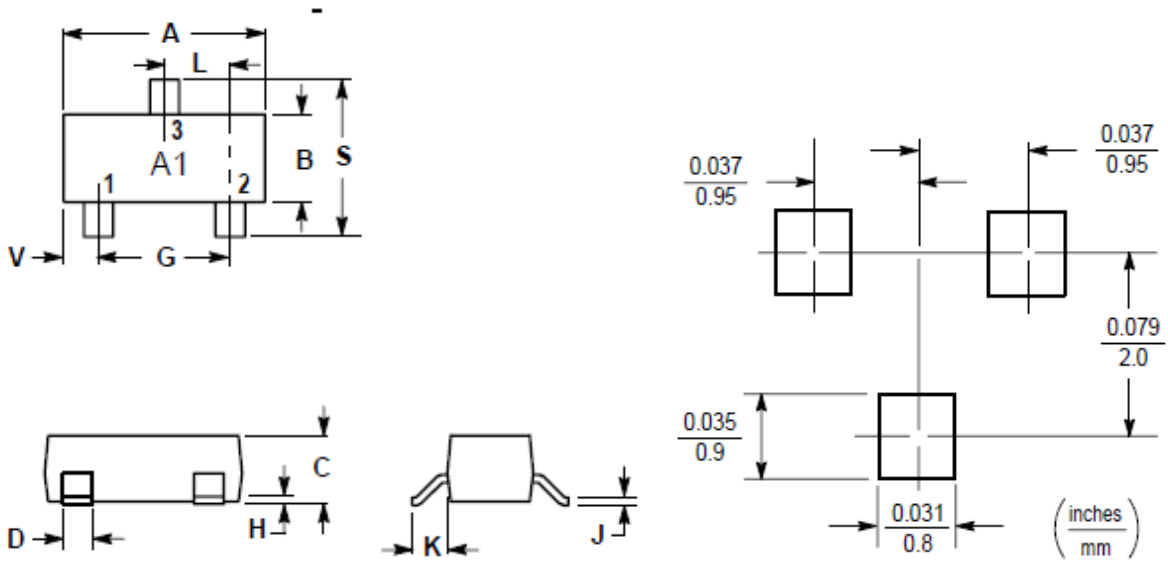

DIM	MILLIMETERS		INCHES	
	MIN	MAX	MIN	MAX
A	2.80	3.04	0.1102	0.1197
B	1.20	1.40	0.0472	0.0551
C	0.89	1.11	0.0350	0.0440
D	0.37	0.50	0.0150	0.0200
G	1.78	2.04	0.0701	0.0807
H	0.013	0.100	0.0005	0.0040
J	0.085	0.177	0.0034	0.0070
K	0.35	0.69	0.0140	0.0285
L	0.89	1.02	0.0350	0.0401
S	2.10	2.64	0.0830	0.1039
V	0.45	0.60	0.0177	0.0236



IMPORTANT NOTICE

AiT Components (AiT) reserves the right to make changes to any its product, specifications, to discontinue any integrated circuit product or service without notice, and advises its customers to obtain the latest version of relevant information to verify, before placing orders, that the information being relied on is current.

AiT Components' integrated circuit products are not designed, intended, authorized, or warranted to be suitable for use in life support applications, devices or systems or other critical applications. Use of AiT products in such applications is understood to be fully at the risk of the customer. As used herein may involve potential risks of death, personal injury, or server property, or environmental damage. In order to minimize risks associated with the customer's applications, the customer should provide adequate design and operating safeguards.

AiT Components assumes to no liability to customer product design or application support. AiT warrants the performance of its products of the specifications applicable at the time of sale.