



DESCRIPTION

The FM101W ~ FM107W are available in SOD-123FL package

FEATURES

- Available in SOD-123FL package

ORDERING INFORMATION

Package Type	Part Number
SOD-123FL	FM101W
	FM102W
	FM103W
	FM104W
	FM105W
	FM106W
	FM107W
Note	SPQ: 3,000pcs/Reel
AiT provides all RoHS Compliant Products	

PIN DESCRIPTION



1. CATHODE
2. ANODE



ABSOLUTE MAXIMUM RATINGS AND ELECTRICAL CHARACTERISTICS

Ratings at 25°C ambient temperature unless otherwise specified. Single phase half-wave 60 Hz , resistive or inductive load, for capacitive load current derate by 20 %.

Parameter	Symbol	FM 101W	FM 102W	FM 103W	FM 104W	FM 105W	FM 106W	FM 107W	Unit
Maximum Repetitive Peak Reverse Voltage	V_{RRM}	50	100	200	400	600	800	1000	V
Maximum RMS Voltage	V_{RMS}	35	70	140	280	420	560	700	V
Maximum DC Blocking Voltage	V_{DC}	50	100	200	400	600	800	1000	V
Maximum Average Forward Rectified Current at $T_A=65^\circ\text{C}$	$I_{F(AV)}$	1.0							A
Peak Forward Surge Current 8.3ms Single Half Sine Wave Superimposed on Rated Load (JEDEC Method)	I_{FSM}	25							A
Maximum Instantaneous Forward Voltage at 1A	V_F	1.3							V
Maximum DC Reverse Current at Rated DC Blocking Voltage	I_R	$T_A=25^\circ\text{C}$ 5 $T_A=100^\circ\text{C}$ 125							μA
Maximum Reverse Recovery Time ^{NOTE1}	t_{rr}	150				250	500		ns
Typical Junction Capacitance ^{NOTE2}	C_J	15							pF
Operating and Storage Temperature Range	T_J, T_{STG}	-55 ~150							$^\circ\text{C}$

NOTE1: Measured with $I_F = 0.5\text{A}$, $I_R = 1\text{A}$, $I_{rr} = 0.25\text{A}$

NOTE2: Measured at 1MHz and applied reverse voltage of 4V D.C



TYPICAL CHARACTERISTICS

Figure. 1 Forward Current Derating Curve

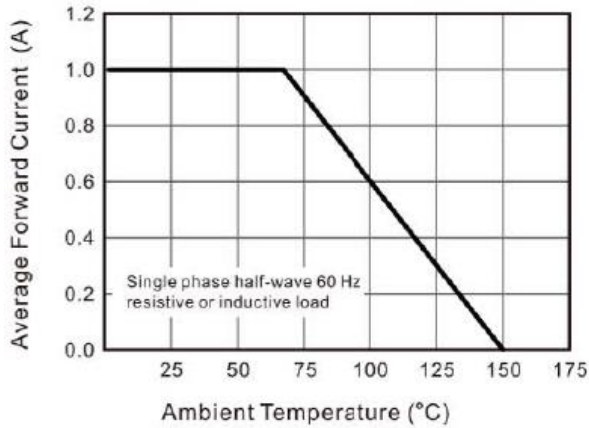

Figure. 2 Typical Reverse Characteristics

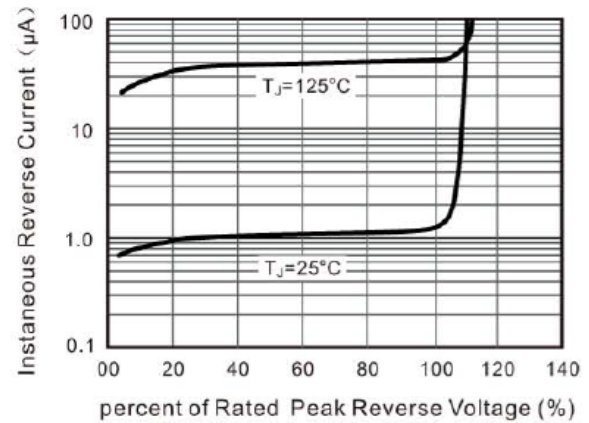

Figure. 3 Typical Instantaneous Forward Characteristic

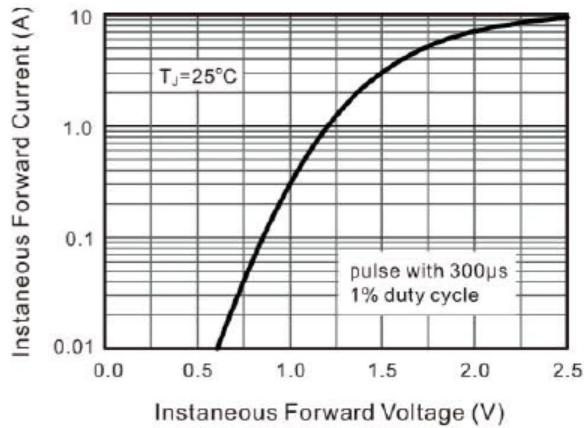

Figure. 4 Typical Junction Capacitance

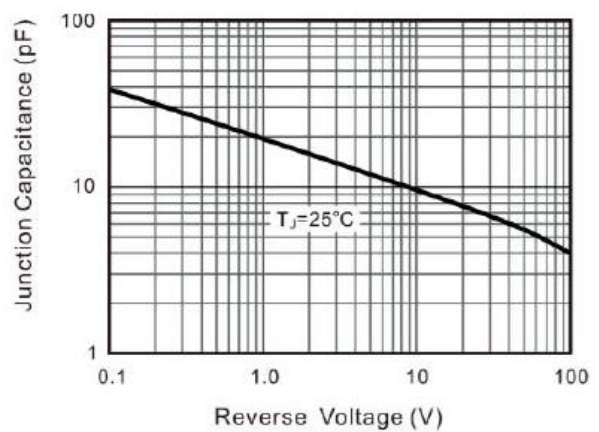
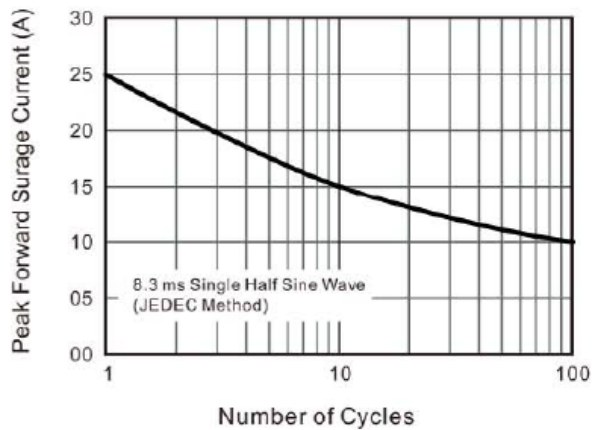

Figure. 5 Maximum Non-Repetitive Peak Forward Surge Current





PACKAGE INFORMATION

Dimension in SOD-123FL (Unit: mm)

Plastic surface mounted package; 2 leads

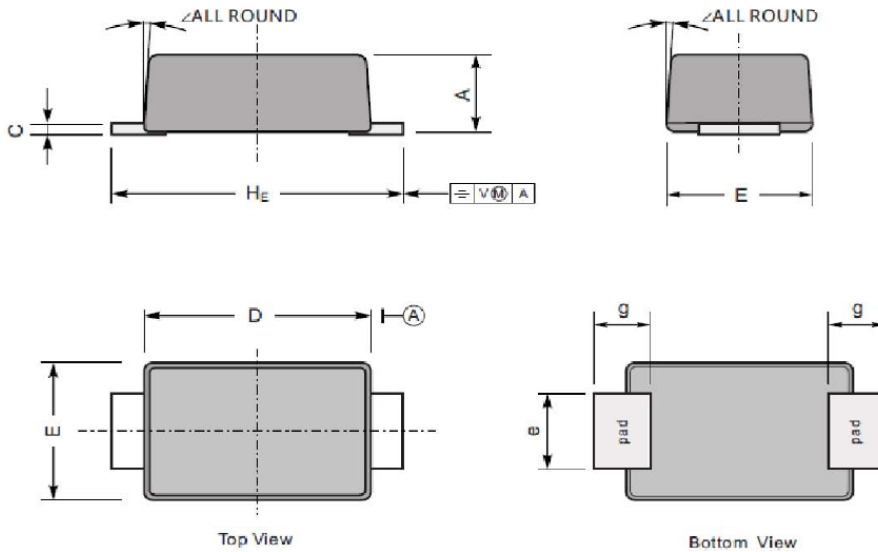

The recommended mounting pad size

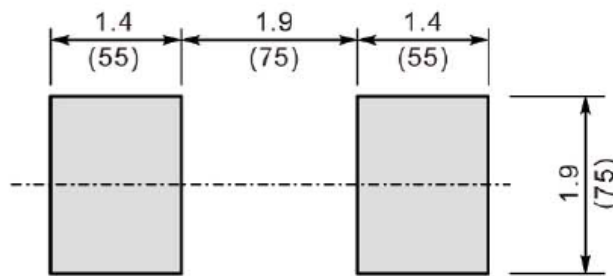

Unit: $\frac{\text{mm}}{\text{mil}}$

UNIT		A	B	C	E	e	g	H _E	∠
mm	Max	1.1	0.20	2.9	1.9	1.1	0.9	3.8	7°
	Min	0.9	0.12	2.6	1.7	0.8	0.7	3.5	
mil	Max	43	7.9	114	75	43	35	150	
	Min	35	4.7	102	67	31	28	138	



IMPORTANT NOTICE

AiT Semiconductor Inc. (AiT) reserves the right to make changes to any its product, specifications, to discontinue any integrated circuit product or service without notice, and advises its customers to obtain the latest version of relevant information to verify, before placing orders, that the information being relied on is current.

AiT Semiconductor Inc. 's integrated circuit products are not designed, intended, authorized, or warranted to be suitable for use in life support applications, devices or systems or other critical applications. Use of AiT products in such applications is understood to be fully at the risk of the customer. As used herein may involve potential risks of death, personal injury, or severe property, or environmental damage. In order to minimize risks associated with the customer's applications, the customer should provide adequate design and operating safeguards.

AiT Semiconductor Inc. assumes to no liability to customer product design or application support. AiT warrants the performance of its products of the specifications applicable at the time of sale.