



## DESCRIPTION

The MBR220F~MBR2200F are available in SOD-123FL package

## FEATURES

- Metal silicon junction, majority carrier conduction
- For surface mounted applications
- Low power loss, high efficiency
- High forward surge current capability
- For use in low voltage, high frequency inverters, free wheeling, and polarity protection applications
- Available in SOD-123FL package

## ORDERING INFORMATION

Package Type	Part Number
SOD-123FL	MBR220F
	MBR240F
	MBR260F
	MBR280F
	MBR2100F
	MBR2120F
	MBR2150F
	MBR2200F
Note	SPQ: 3,000pcs/Reel
AiT provides all RoHS Compliant Products	

## PIN DESCRIPTION





## ABSOLUTE MAXIMUM RATINGS AND ELECTRICAL CHARACTERISTICS

Ratings at 25°C ambient temperature unless otherwise specified. Single phase, half wave, 60Hz resistive or inductive load, for capacitive load, derate by 20%

Parameter	Symbol	MBR 220F	MBR 240F	MBR 260F	MBR 280F	MBR 2100F	MBR 2120F	MBR 2150F	MBR 2200F	Unit
Maximum Repetitive Peak Reverse Voltage	$V_{RRM}$	20	40	60	80	100	120	150	200	V
Maximum RMS Voltage	$V_{RMS}$	14	28	42	56	80	100	105	140	V
Maximum DC Blanking Voltage	$V_{DC}$	20	40	60	80	100	120	150	200	V
Maximum Average Forward Rectified Current	$I_{F(AV)}$	2.0								A
Peak Forward Surge Current, 8.3ms Single Half Sine-wave Superimposed on Rated Load (JEDEC method)	$I_{FSM}$	40								A
Max Instantaneous Forward Voltage at 2A	$V_F$	0.55		0.70		0.85		0.95		V
Maximum DC Reverse Current at Rated DC Reverse Voltage	$I_R$	$T_A=25^\circ\text{C}$			$T_A=100^\circ\text{C}$					mA
		0.5			0.3					
		10			5					
Typical Junction Capacitance <sup>NOTE1</sup>	$C_J$	220			80					pF
Operating Junction Temperature Range	$T_J$	-55~+125								°C
Storage Temperature Range	$T_{STG}$	-55~+150								°C

NOTE1: Measured at 1MHz and applied reverse voltage of 4V D.C.



## TYPICAL CHARACTERISTICS

Figure 1. Forward Current Derating Curve

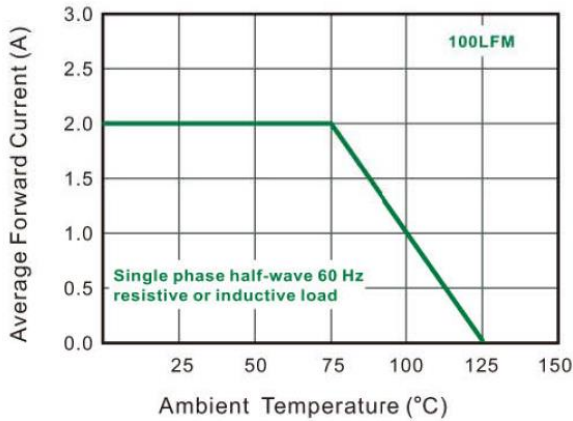

Figure 2. Typical Reverse Characteristics

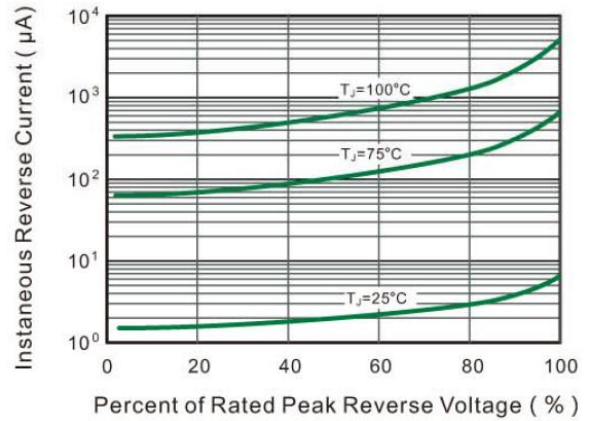

Figure 3. Typical Forward Characteristic

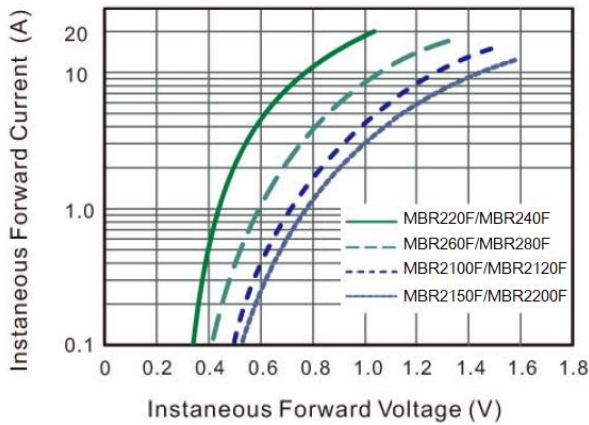

Figure 4. Typical Junction Capacitance

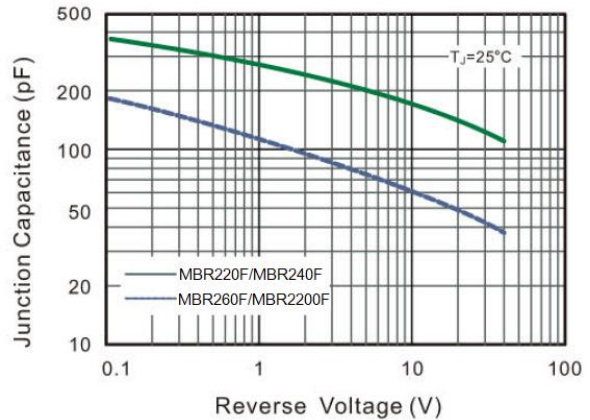
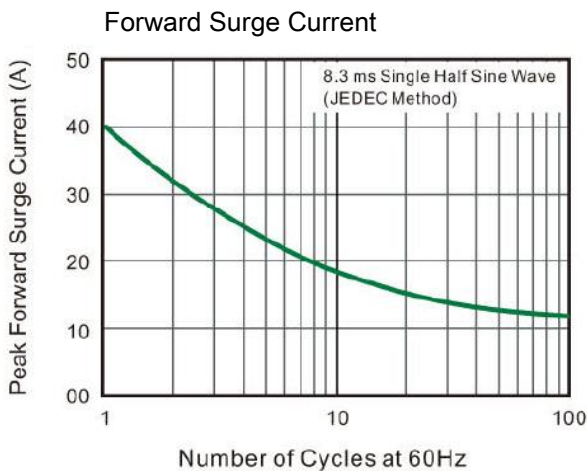
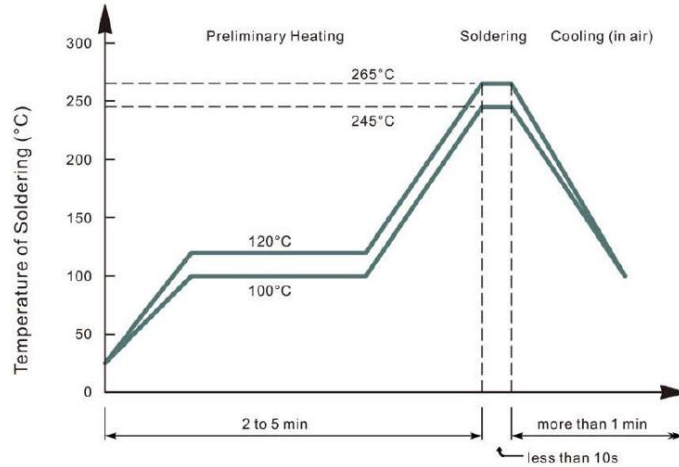

Figure 5. Maximum Non-Repetitive Peak Forward Surge Current





### Recommended condition of flow soldering



### Recommended condition of reflow soldering

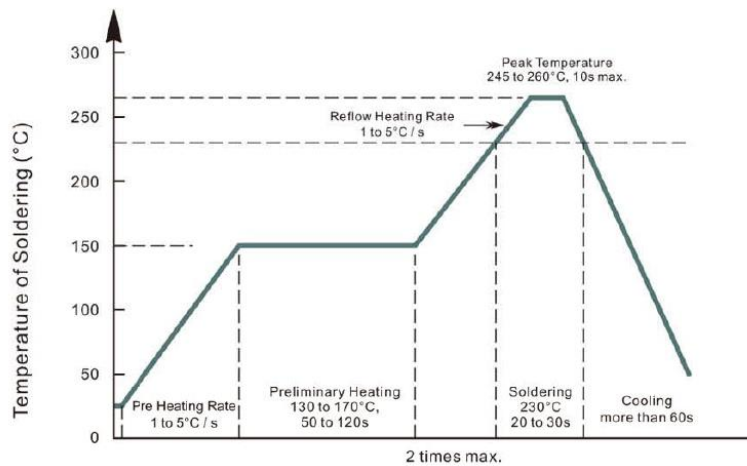

Recommended peak temperature is over 245°C. If peak temperature is below 245°C, you may adjust the following parameters; time length of peak temperature (longer), time length of soldering (longer), thickness of solder paste (thicker)

### Condition of hand soldering

Temperature: 320°C

Time: 3s max.

Times: one time

### Remark

Lead free solder paste (96.5Sn/3.0Ag/0.5Cu)



**PACKAGE INFORMATION**

Dimension in SOD-123FL (Unit: mm)

Plastic Surface mounted package; 2 leads

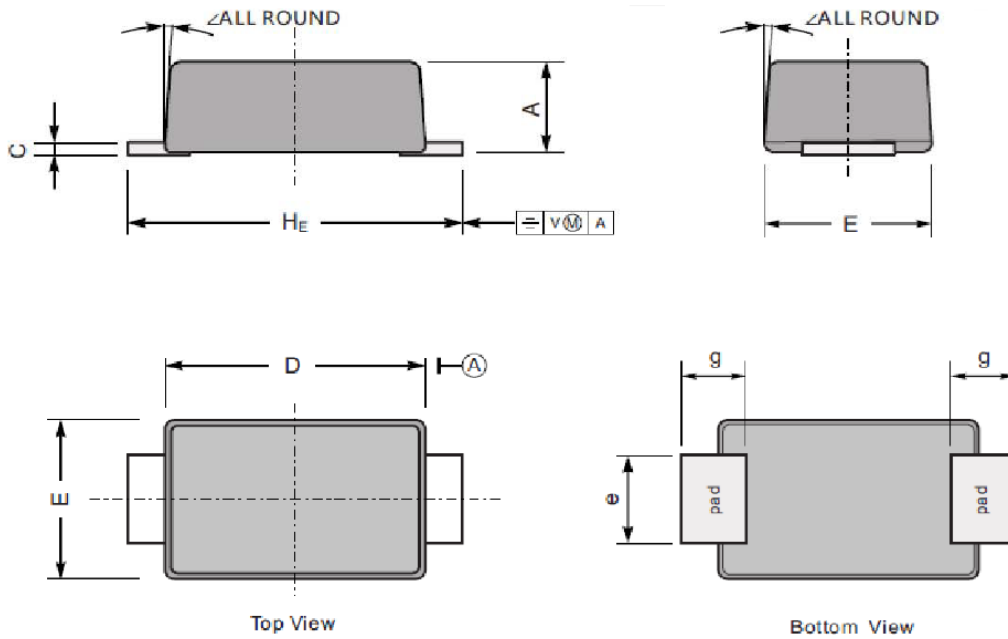

The recommended mounting pad size

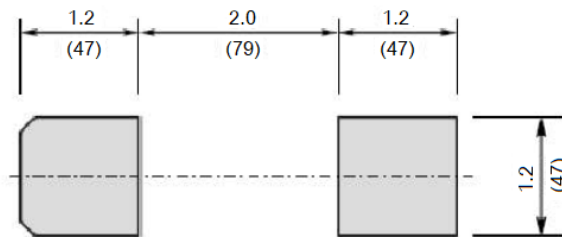

Unit:  $\frac{\text{mm}}{\text{mil}}$

UNIT		A	C	D	E	e	g	H <sub>E</sub>	$\angle$
mm	Max	1.1	0.20	2.9	1.9	1.1	0.9	3.8	7°
	Min	0.9	0.12	2.6	1.7	0.8	0.7	3.5	
mil	Max	43	7.9	114	75	43	35	150	
	Min	35	4.7	102	67	31	28	138	



## IMPORTANT NOTICE

AiT Semiconductor Inc. (AiT) reserves the right to make changes to any its product, specifications, to discontinue any integrated circuit product or service without notice, and advises its customers to obtain the latest version of relevant information to verify, before placing orders, that the information being relied on is current.

AiT Semiconductor Inc.'s integrated circuit products are not designed, intended, authorized, or warranted to be suitable for use in life support applications, devices or systems or other critical applications. Use of AiT products in such applications is understood to be fully at the risk of the customer. As used herein may involve potential risks of death, personal injury, or severe property, or environmental damage. In order to minimize risks associated with the customer's applications, the customer should provide adequate design and operating safeguards.

AiT Semiconductor Inc. assumes to no liability to customer product design or application support. AiT warrants the performance of its products of the specifications applicable at the time of sale.