



## DESCRIPTION

The P6SMB is available in SMB package

## MECHANICAL DATA

Case: SMB

Terminals: Solderable per MIL-STD-750,  
Method 2026

Approx. Weight: 0.055g / 0.002oz

## FEATURES

- For surface mounted applications in order to optimize board space.
- Low profile package
- Glass passivated junction
- Low inductance
- Plastic package has Underwriters Laboratory
- Flammability
- Available in SMB package

## PIN DESCRIPTION

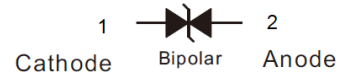
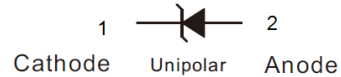

## ORDERING INFORMATION

Package Type	Part Number	
	UNI	BI
SMB	P6SMB6.8A	P6SMB6.8CA
	P6SMB7.5A	P6SMB7.5CA
	P6SMB8.2A	P6SMB8.2CA
	P6SMB9.1A	P6SMB9.1CA
	P6SMB10A	P6SMB10CA
	P6SMB11A	P6SMB11CA
	P6SMB12A	P6SMB12CA
	P6SMB13A	P6SMB13CA
	P6SMB15A	P6SMB15CA
	P6SMB16A	P6SMB16CA
	P6SMB18A	P6SMB18CA
	P6SMB20A	P6SMB20CA
	P6SMB22A	P6SMB22CA
	P6SMB24A	P6SMB24CA
	P6SMB27A	P6SMB27CA
	P6SMB30A	P6SMB30CA
	P6SMB33A	P6SMB33CA
	P6SMB36A	P6SMB36CA
	P6SMB39A	P6SMB39CA
	P6SMB43A	P6SMB43CA
	P6SMB47A	P6SMB47CA
	P6SMB51A	P6SMB51CA
	P6SMB56A	P6SMB56CA
	P6SMB58A	P6SMB58CA
P6SMB62A	P6SMB62CA	
P6SMB68A	P6SMB68CA	

Package Type	Part Number	
	UNI	BI
SMB	P6SMB75A	P6SMB75CA
	P6SMB82A	P6SMB82CA
	P6SMB91A	P6SMB91CA
	P6SMB100A	P6SMB100CA
	P6SMB110A	P6SMB110CA
	P6SMB120A	P6SMB120CA
	P6SMB130A	P6SMB130CA
	P6SMB150A	P6SMB150CA
	P6SMB160A	P6SMB160CA
	P6SMB170A	P6SMB170CA
	P6SMB180A	P6SMB180CA
	P6SMB200A	P6SMB200CA
	P6SMB220A	P6SMB220CA
	P6SMB250A	P6SMB250CA
	P6SMB300A	P6SMB300CA
	P6SMB350A	P6SMB350CA
	P6SMB400A	P6SMB400CA
	P6SMB440A	P6SMB440CA
	P6SMB480A	P6SMB480CA
	P6SMB510A	P6SMB510CA
	P6SMB530A	P6SMB530CA
P6SMB540A	P6SMB540CA	
P6SMB550A	P6SMB550CA	
Note	SPQ: 3000pcs/ Reel	
AiT provides all RoHS Compliant Products		



## ABSOLUTE MAXIMUM RATINGS

Ratings at 25°C ambient temperature unless otherwise specified.

P <sub>PPM</sub> , Peak Pulse Power Dissipation on 10/1000 s waveform <sup>NOTE1,2 (Fig.1)</sup>		600W
I <sub>FSM(UNI)</sub> , Peak Forward Surge Current, 8.3ms Single Half Sine-Wave Superimposed on Rated Load, (JEDEC Method) <sup>NOTE3 (Fig4)</sup>		100A
I <sub>PPM</sub> , Peak Pulse Current on 10/1000us waveform <sup>NOTE1 (Fig 3)</sup>		see Table 1
C <sub>J</sub> , Typical Junction capacitance at V <sub>R</sub> =4V, f=1MHz		390pF
V <sub>ESD1</sub> , ESD Voltage per IEC6100-4-2	Contact	±30kV
V <sub>ESD2</sub> , ESD Voltage per IEC6100-4-2	Air	±30kV
R <sub>θJA</sub> , Typical Thermal Resistance Junction to Ambient <sup>NOTE2</sup>		100°C/W
T <sub>J</sub> , T <sub>STG</sub> , Operating Junction Temperature and Storage Temperature Range		-65°C~+150°C

Stresses above may cause permanent damage to the device. These are stress ratings only and functional operation of the device at these or any other conditions beyond those indicated in the Electrical Characteristics are not implied. Exposure to absolute maximum rating conditions for extended periods may affect device reliability.

NOTE1: Non-repetitive current pulse, per Fig.3 and derated above T<sub>A</sub> = 25 per Fig. 2.

NOTE2: Mounted on 5 mm<sup>2</sup> (0.13mm thick) land areas.

NOTE3: Measured on 8.3ms, single half sine-wave or equivalent square wave, duty cycle=4 pulses per minute maximum.

NOTE4: Peak pulse power waveform is 10/1000μS.



## ELECTRICAL CHARACTERISTICS

Table 1

Part Number		Reverse Stand-off Voltage	Breakdown Voltage $V_{BR} @ I_T$		Test Current $I_T$	Maximum Reverse Leakage	Max. Clamp Voltage $V_C @ I_{PP}$	Peak Pulse Current $I_{PP}$
			$V_{RMW}$	Min				
UNI	BI	V	V	V	mA	$\mu A$	V	A
<b>600W Transient Voltage Suppressor</b>								
P6SMB6.8A	P6SMB6.8CA	5.8	6.45	7.14	10	1000	10.5	58.1
P6SMB7.5A	P6SMB7.5CA	6.4	7.13	7.88	10	500	11.3	54
P6SMB8.2A	P6SMB8.2CA	7.02	7.79	8.61	10	200	12.1	50.4
P6SMB9.1A	P6SMB9.1CA	7.78	8.65	9.55	1	50	13.4	45.5
P6SMB10A	P6SMB10CA	8.55	9.5	10.5	1	10	14.5	42.1
P6SMB11A	P6SMB11CA	9.4	10.5	11.6	1	5	15.6	39.1
P6SMB12A	P6SMB12CA	10.2	11.4	12.6	1	5	16.7	36.5
P6SMB13A	P6SMB13CA	11.1	12.4	13.7	1	1	18.2	33.5
P6SMB15A	P6SMB15CA	12.8	14.3	15.8	1	1	21.2	28.8
P6SMB16A	P6SMB16CA	13.6	15.2	16.8	1	1	22.5	27.1
P6SMB18A	P6SMB18CA	15.3	17.1	18.9	1	1	25.5	24.2
P6SMB20A	P6SMB20CA	17.1	19	21	1	1	27.7	22
P6SMB22A	P6SMB22CA	18.8	20.9	23.1	1	1	30.6	19.9
P6SMB24A	P6SMB24CA	20.5	22.8	25.2	1	1	33.2	18.4
P6SMB27A	P6SMB27CA	23.1	25.7	28.4	1	1	37.5	16.3
P6SMB30A	P6SMB30CA	25.6	28.5	31.5	1	1	41.4	14.7
P6SMB33A	P6SMB33CA	28.2	31.4	34.7	1	1	45.7	13.3
P6SMB36A	P6SMB36CA	30.8	34.2	37.8	1	1	49.9	12.2
P6SMB39A	P6SMB39CA	33.3	37.1	41	1	1	53.9	11.3
P6SMB43A	P6SMB43CA	36.8	40.9	45.2	1	1	59.3	10.3
P6SMB47A	P6SMB47CA	40.2	44.7	49.4	1	1	64.8	9.4
P6SMB51A	P6SMB51CA	43.6	48.5	53.6	1	1	70.1	8.7
P6SMB56A	P6SMB56CA	47.8	53.2	58.8	1	1	77	7.9
P6SMB58A	P6SMB58CA	52.78	55.1	60.9	1	1	79.8	7.7
P6SMB62A	P6SMB62CA	53	58.9	65.1	1	1	85	7.2
P6SMB68A	P6SMB68CA	58.1	64.6	71.4	1	1	92	6.6
P6SMB75A	P6SMB75CA	64.1	71.3	78.8	1	1	103	5.9
P6SMB82A	P6SMB82CA	70.1	77.9	86.1	1	1	113	5.4
P6SMB91A	P6SMB91CA	77.8	86.5	95.5	1	1	125	4.9
P6SMB100A	P6SMB100CA	85.5	95	105	1	1	137	4.5
P6SMB110A	P6SMB110CA	94	105	116	1	1	152	4
P6SMB120A	P6SMB120CA	102	114	126	1	1	165	3.7
P6SMB130A	P6SMB130CA	111	124	137	1	1	179	3.4
P6SMB150A	P6SMB150CA	128	143	158	1	1	207	2.9



Part Number		Reverse Stand-off Voltage	Breakdown Voltage $V_{BR} @ I_T$		Test Current $I_T$	Maximum Reverse Leakage	Max. Clamp Voltage $V_C @ I_{PP}$	Peak Pulse Current $I_{PP}$
			$V_{RMW}$	Min				
UNI	BI	V	V	V	mA	$\mu A$	V	A
P6SMB160A	P6SMB160CA	136	152	168	1	1	219	2.8
P6SMB170A	P6SMB170CA	145	162	179	1	1	234	2.6
P6SMB180A	P6SMB180CA	154	171	189	1	1	246	2.5
P6SMB200A	P6SMB200CA	171	190	210	1	1	274	2.2
P6SMB220A	P6SMB220CA	185	209	231	1	1	328	1.9
P6SMB250A	P6SMB250CA	214	237	263	1	1	344	1.8
P6SMB300A	P6SMB300CA	256	285	315	1	1	414	1.5
P6SMB350A	P6SMB350CA	300	332	368	1	1	482	1.3
P6SMB400A	P6SMB400CA	342	380	420	1	1	548	1.1
P6SMB440A	P6SMB440CA	376	418	462	1	1	602	1
P6SMB480A	P6SMB480CA	408	456	504	1	1	658	0.9
P6SMB510A	P6SMB510CA	434	485	535	1	1	698	0.9
P6SMB530A	P6SMB530CA	451	503.5	556.5	1	1	725	0.8
P6SMB540A	P6SMB540CA	460	513	567	1	1	740	0.8
P6SMB550A	P6SMB550CA	468	522.5	577.5	1	1	760	0.8



## TYPICAL CHARACTERISTICS

Figure 1. Peak Pulse Power Rating Curve

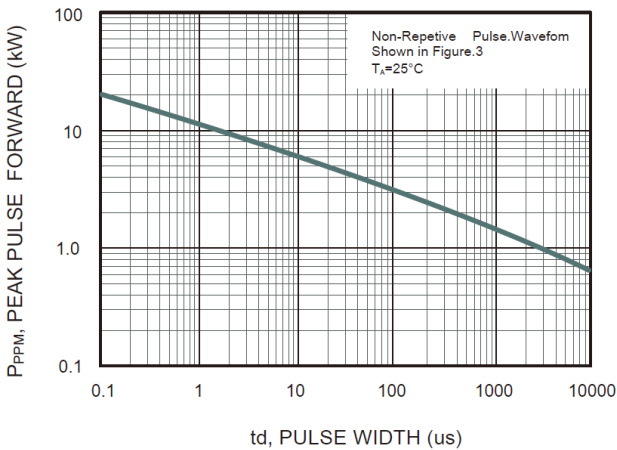

Figure 2. Forward Current Derating Curve

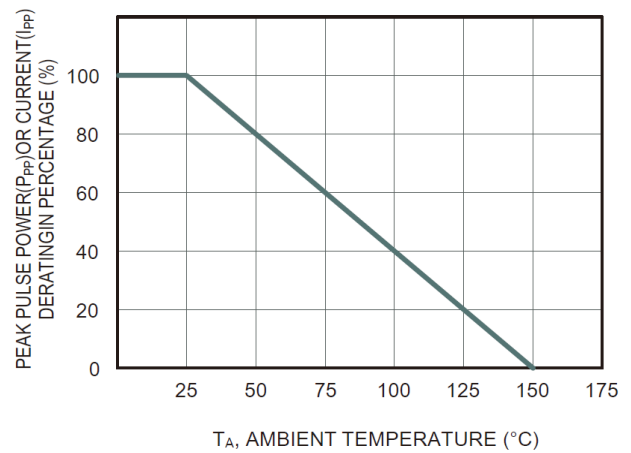

Figure 3. Pulse Waveform

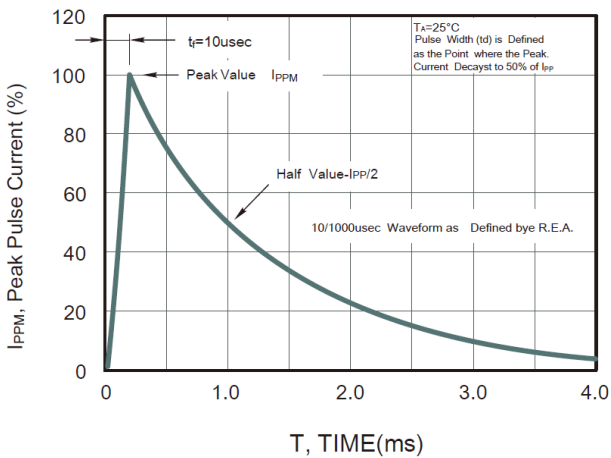
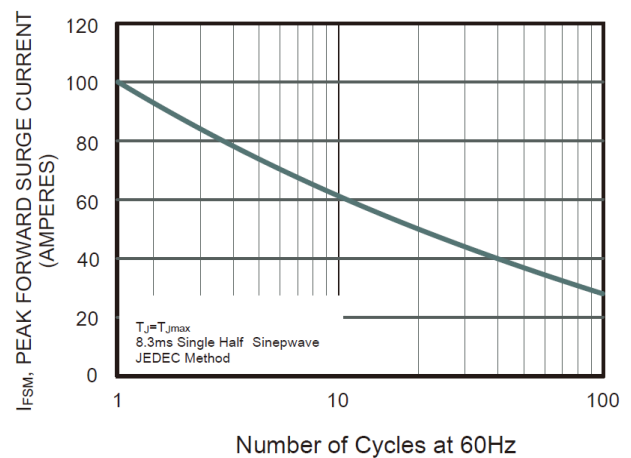

Figure 4. Maximum Non-Repetitive Peak Forward Surge Current





**PACKAGE INFORMATION**

Dimension in SMB Package (Unit: mm)

Plastic surface mounted package; 2 leads

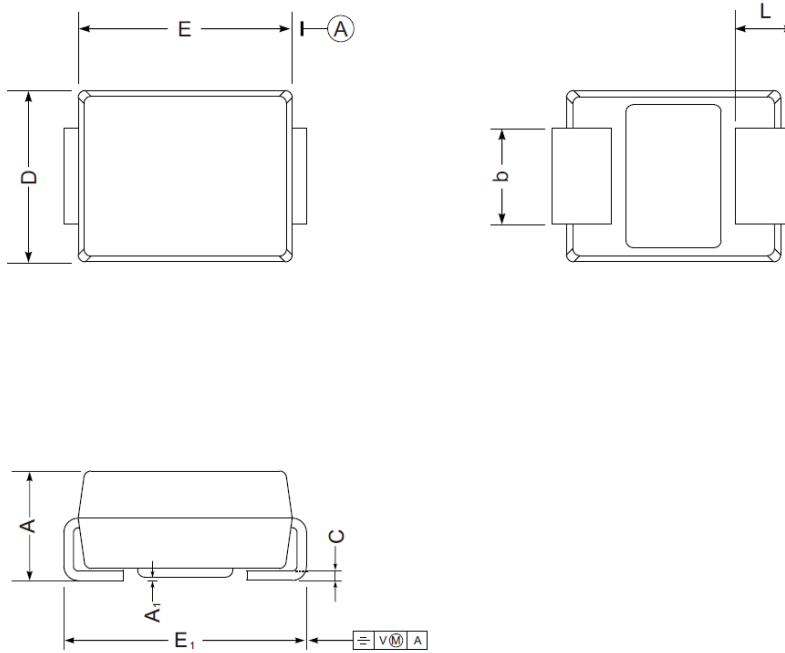

**The recommended mounting pad size**

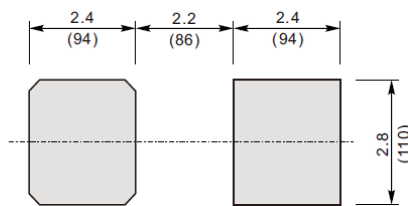

Unit :  $\frac{\text{mm}}{\text{(mil)}}$

UNIT		A	E	D	E <sub>1</sub>	A <sub>1</sub>	L	C	b
mm	Max	2.44	4.70	3.94	5.59	0.20	1.5	0.305	2.11
	Min	2.13	4.06	3.3	5.08	0.05	0.8	0.152	1.91
mil	Max	96	185	155	220	7.9	59	12	83
	Min	84	160	130	200	2.0	32	6	75



## IMPORTANT NOTICE

AiT Semiconductor Inc. (AiT) reserves the right to make changes to any its product, specifications, to discontinue any integrated circuit product or service without notice, and advises its customers to obtain the latest version of relevant information to verify, before placing orders, that the information being relied on is current.

AiT Semiconductor Inc.'s integrated circuit products are not designed, intended, authorized, or warranted to be suitable for use in life support applications, devices or systems or other critical applications. Use of AiT products in such applications is understood to be fully at the risk of the customer. As used herein may involve potential risks of death, personal injury, or severe property, or environmental damage. In order to minimize risks associated with the customer's applications, the customer should provide adequate design and operating safeguards.

AiT Semiconductor Inc. assumes to no liability to customer product design or application support. AiT warrants the performance of its products of the specifications applicable at the time of sale.